

Pyxis®

SP-600 Water Multimeter

Conductivity, TDS, Resistivity, pH, ORP, Temp, F/T-CI DPD



Pyxis Lab® Inc.

1729 Majestic Dr. (Suite 5)

Lafayette, CO 80026

www.pyxis-lab.com

USER MANUAL

SP-600 Water Multimeter User Manual

March 10, 2022

Rev. 1.6

Pyxis Lab, Inc.

21242 Spell Circle

Tomball, TX 77375 USA

www.pyxis-lab.com

© 2017 Pyxis Lab, Inc.

Pyxis Lab Proprietary and Confidential

Table of Contents

1	Introduction	3
1.1	Main Features	3
2	Specifications	4
3	Unpacking Instrument	5
3.1	Standard Accessories	5
3.2	Optional Accessories	5
4	Installation	6
4.1	Main Module Battery Installation	6
4.2	pH/ORP Module Battery Installation	7
5	Instrument Overview	8
5.1	pH/ORP Cell Cap Seal	8
5.2	Control Keys	9
5.3	Main Module On/Off	10
5.4	pH/ORP Module On/Off	10
6	Measurement	10
6.1	Switch Measurement Mode	10
6.2	Conductivity Measurement	11
6.3	Total Dissolved Solids (TDS) Measurement	11
6.4	Resistivity Measurement	14
6.5	DPD Free and Total Chlorine Measurement	14
6.6	Temperature Measurement	16
6.7	pH/ORP Measurement	16
7	Calibration	18
7.1	Conductivity Calibration	18
7.2	DPD Free and Total Chlorine Calibration	22
7.3	pH Calibration	28
7.4	ORP Calibration	30
8	Device Information and Diagnosis	32
8.1	Conductivity/Chlorine Sample Cell Cleanliness Check	33
8.2	Bluetooth Connection to Devices	34
8.3	Factory Reset	35
9	Use with uPyxis® Mobile App	36
9.1	Download uPyxis® Mobile App	36
9.2	Connecting to uPyxis® Mobile App	37
9.3	System Screen	38
9.4	Setting Screen	39
9.5	Datalog Screen	40

10 Use with uPyxis® Desktop App	41
10.1 Install uPyxis® Desktop App	41
10.2 Connecting to uPyxis® Desktop App	42
10.3 System Screen	43
10.4 Setting Screen	44
10.5 Datalog Screen	44
11 Device Maintenance and Precaution	45
11.1 Maintenance Best Practices	45
11.2 Methods to Cleaning the SP-600	46
11.3 Storage	46
11.4 pH/ORP Module Replacement	47
12 Regulatory Approval	49
13 Contact Us	49

Warranty Information

Confidentiality

The information contained in this manual may be confidential and proprietary and is the property of Pyxis Lab, Inc. Information disclosed herein shall not be used to manufacture, construct, or otherwise reproduce the goods described. Information disclosed herein shall not be disclosed to others or made public in any manner without the express written consent of Pyxis Lab, Inc.

Standard Limited Warranty

Pyxis Lab warrants its products for defects in materials and workmanship. Pyxis Lab will, at its option, repair or replace instrument components that prove to be defective with new or remanufactured components (i.e., equivalent to new). The warranty set forth is exclusive and no other warranty, whether written or oral, is expressed or implied.

Warranty Term

The Pyxis warranty term is thirteen (13) months ex-works. In no event shall the standard limited warranty coverage extend beyond thirteen (13) months from original shipment date.

Warranty Service

Damaged or dysfunctional instruments may be returned to Pyxis for repair or replacement. In some instances, replacement instruments may be available for short duration loan or lease.

Pyxis warrants that any labor services provided shall conform to the reasonable standards of technical competency and performance effective at the time of delivery. All service interventions are to be reviewed and authorized as correct and complete at the completion of the service by a customer representative, or designate. Pyxis warrants these services for 30 days after the authorization and will correct any qualifying deficiency in labor provided that the labor service deficiency is exactly related to the originating event. No other remedy, other than the provision of labor services, may be applicable.

Repair components (parts and materials), but not consumables, provided during a repair, or purchased individually, are warranted for 90 days ex-works for materials and workmanship. In no event will the incorporation of a warranted repair component into an instrument extend the whole instrument's warranty beyond its original term.

Warranty Shipping

A Repair Authorization (RA) Number must be obtained from Pyxis Technical Support before any product can be returned to the factory. Pyxis will pay freight charges to ship replacement or repaired products to the customer. The customer shall pay freight charges for returning products to Pyxis. Any product returned to the factory without an RA number will be returned to the customer. To receive an RMA you can generate a request on our website at <https://pyxis-lab.com/request-tech-support/>.

Pyxis Technical Support

Contact Pyxis Technical Support at +1 (866) 203-8397, service@pyxis-lab.com, or by filling out a request for support at <https://pyxis-lab.com/request-tech-support/>.

1 Introduction

The Pyxis SP-600 is a uniquely designed handheld multimeter that measures seven key parameters. It is a cuvette-less device. Less than 5 mL water sample is needed to fill either of the two sample cells for proper measurement. The measurable parameters are:

- Conductivity/Total Dissolved Solids (TDS)
- Resistivity
- DPD Free and Total Chlorine
- Temperature (°C & °F)
- pH
- ORP

1.1 Main Features

The SP-600 includes the following features:

- Combine conductivity, chlorine, and pH/ORP measurement in a single, rugged meter
- 0.05 $\mu\text{S}/\text{cm}$ –200 mS/cm conductivity or 10 $\Omega\cdot\text{cm}$ –30 $\text{M}\Omega\cdot\text{cm}$ resistivity measurement ranges
- Customizable TDS to conductivity ratio (default set as 0.67x $\mu\text{S}/\text{cm}$ at mid range)
- Wireless and independent use of pH/ORP module
- Modular pH/ORP design with extra-large junction capacity providing increased service life
- Replaceable battery in pH/ORP module
- Easy replacement of the pH/ORP module without the need to disassemble the main module
- Customization and firmware upgrades via wireless connection to **uPyxis**® Mobile/Desktop App
- Long battery life with 10,000+ readings
- Self-diagnosis during calibrations

2 Specifications

Table 1. SP-600 Specifications

Item	Specification*
P/N	50353
Conductivity Range [†]	0.05 μ S–200 mS
Conductivity Resolution	\pm 1% or \pm 0.02 μ S/cm
Total Dissolved Solids (TDS) Range [†]	0.05–135,000 ppm
Total Dissolved Solids (TDS) Resolution	\pm 1%
Resistivity Range	10 Ω ·cm–30 M Ω ·cm
Resistivity Resolution	\pm 1%
DPD Free and Total Chlorine Range	0.02–10.0 ppm
DPD Free and Total Chlorine Resolution	\pm 0.02
Temperature Range	32–160 °F (0–70 °C)
Temperature Resolution	\pm 0.2 °F (\pm 0.1 °C)
pH Range [†]	0–14
pH Resolution	\pm 0.01
ORP Range	\pm 1,500 mV
ORP Resolution	\pm 1 mV
pH/ORP Module [‡]	Wireless and replaceable
Display	Color LCD, visible under direct sunlight
Main Module Power Supply	4 AA alkaline batteries
pH/ORP Module Power Supply	1 ER14250 lithium thionyl chloride battery
Typical Battery Life	10,000 readings
Dimension (L×W×H)	8.19×3.15×1.77 inch (208×80×45 mm)
Weight [§]	1.15 lbs (520 g)
Operational Temperature	32–104 °F (0–40 °C)
Storage Temperature	-4–140 °F (-10–50 °C)
Enclosure Rating	IP67
Regulation	CE

* With Pyxis's continuous improvement policy, these specifications are subject to change without notice.

[†] With Automatic Temperature Compensation (ATC)

[‡] Replacement recommended every 9–12 months

[§] Batteries excluded

3 Unpacking Instrument

Remove the instrument and accessories from the shipping container and inspect each item for any damage that may have occurred during shipment. It is possible that the pH/ORP Cell Cap Seal can open in shipment, which may result in pH/ORP Storage Solution on the outer shell of the device. This will not cause any damage. Simply wipe down the device with wet cloth and towel dry. Verify that all items listed on the packing slip are included. If any items are missing or damaged, please contact Pyxis Customer Service at service@pyxis-lab.com. During shipping and storage after production, a sponge wetted with the pH/ORP Storage Solution is placed in the pH/ORP Cell Cap Seal. This sponge may be removed and discarded. Some pH/ORP Storage Solution may dry and form white crystals in the surrounding areas of the sample cells. Please rinse the sample cells with a water sample before use.

3.1 Standard Accessories

- Quick-Start Guide
- Four (4) AA alkaline batteries
- Pyxis pH/ORP Storage Solution — 70 mL P/N: 63960
- Bluetooth/USB Adapter for Desktop P/N: MA-NEB
- User Manual available online at <https://pyxis-lab.com/support/>

3.2 Optional Accessories

The following optional accessories can be ordered from Pyxis Customer Service (order@pyxis-lab.com) or Pyxis E-Store at <https://pyxis-lab.com/shop/>.

Table 2. Optional Accessories

Accessory Name	Part Number (P/N)
Replacement pH/ORP Module — Bluetooth	50315
Battery for pH/ORP Module	50778
Pyxis pH/ORP Storage Solution — 70 mL	63960
Pyxis Carrying Case for SP-600	MA-700
Pyxis 200 mV ORP Calibration Standard — 500 mL	57020
Pyxis pH 4-7-10 Calibration Combination Kit — 500 mL ea	57007
Pyxis 1000 μ S Conductivity Calibration Standard — 500 mL	57008
Pyxis DPD Free Chlorine Powder Pillow 10 mL (100 pk)	31002
Pyxis DPD Total Chlorine Powder Pillow 10 mL (100 pk)	31014
Pyxis DPD Chlorine Secondary Standard — 1.0 ppm Solution — 125 mL	21039
Pyxis DPD Chlorine Secondary Standard — 2.0 ppm Solution — 125 mL	21040

4 Installation

4.1 Main Module Battery Installation

The main module of the SP-600 is powered by four AA alkaline batteries. Typical battery life is 10,000 measurements or 6 months. When the battery capacity is critically low, the SP-600 displays a "LOW BATTERY" warning for five seconds and then automatically turns off.

The SP-600 does not turn itself on automatically after the new battery installation. To turn on the SP-600 after new battery installation, press the **OK** key momentarily and release.

The SP-600 has a calendar timer. To prevent the calendar from being reset to the default date and time (01/01/1970, 00:00:00), install the four new batteries within four minutes after the old batteries are removed from the battery compartment. The SP-600 date and time is synchronized automatically when connected with **uPyxis**® Mobile or Desktop App.

The SP-600 battery compartment, shown in Figure 1, is on the back side of the instrument. Batteries are held in place by a cover secured with two Phillips-head screws.

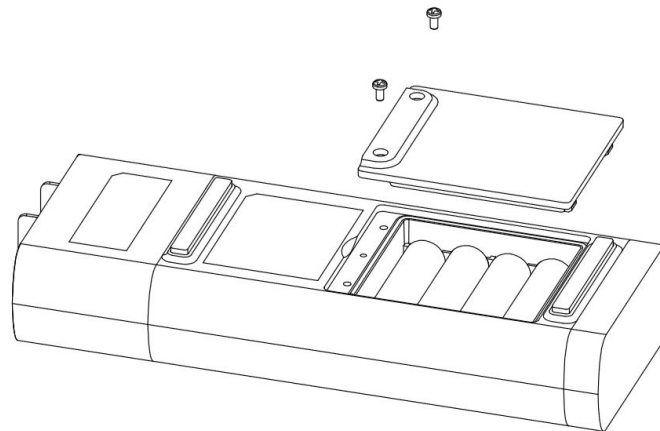

Figure 1. The SP-600 battery compartment

Use the following procedure to install new batteries:

1. Remove the battery compartment cover by loosening the two screws.
2. Remove the old batteries and dispose of them properly.
3. Following the positive and negative terminal signs in the compartment bottom, snap four new AA alkaline batteries firmly into the battery holder.
4. Replace the battery compartment cover and ensure that the sealing O-ring is lying flat on the battery holder.
5. Fasten the two screws.

NOTE Failure to properly seat the O-ring may result in water damage to the SP-600.

4.2 pH/ORP Module Battery Installation

The new pH/ORP module has a lithium thionyl chloride battery (3.7V-ER14250) installed. When the battery capacity is critically low and the main module displays a LOW BATTERY warning, replace the ER14250 battery. Use the following procedure to install a new battery:

1. Unsnap the pH/ORP module from the top of the main module.
2. Remove the battery compartment cover by using a coin or flat-head screwdriver to turn the cover counterclockwise.
3. Remove the old battery and dispose of it properly.
4. Following the orientation of the battery as shown in Figure 2, put a new ER14250 battery into the compartment.
5. Fasten the compartment cover by turning it clockwise.
6. Snap the pH/ORP module back atop the main module.

NOTE Failure to properly fasten the cover may result in battery short-circuit and damage.



Figure 2. Proper orientation of the ER14250 battery

5 Instrument Overview

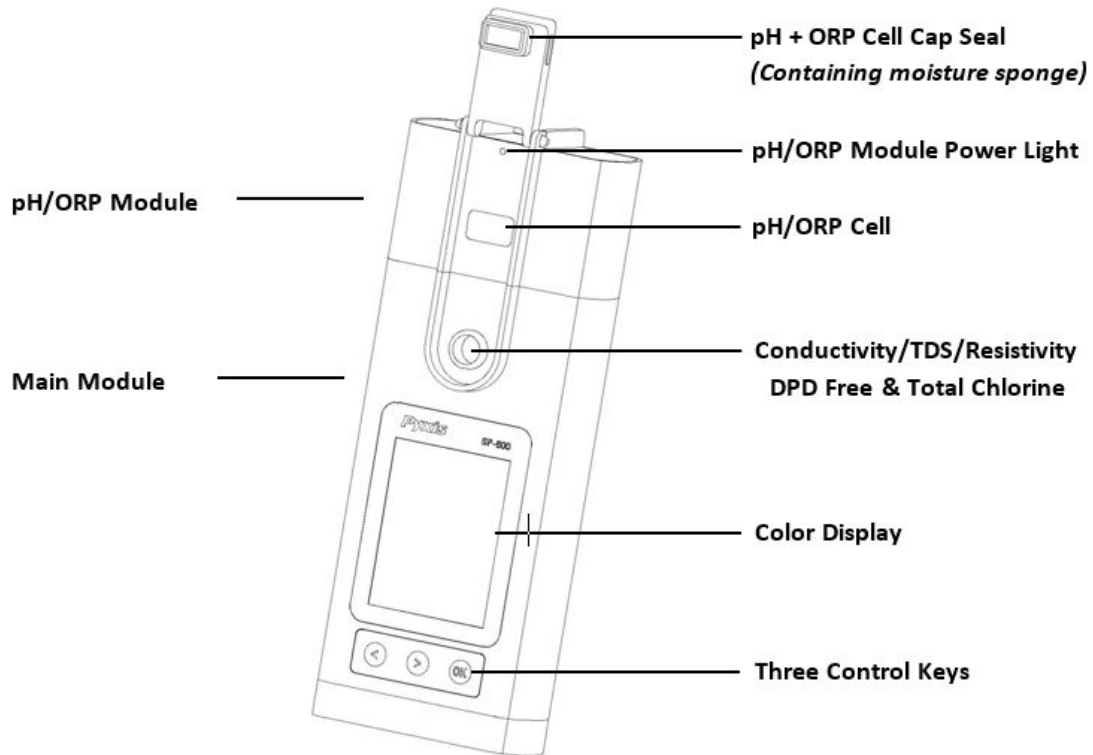

Figure 3.

5.1 pH/ORP Cell Cap Seal



When the SP-600 is in storage, the pH/ORP Cell Cap Seal seals the pH/ORP cell, maintaining a moist environment for the electrodes. For vigorous field use, it is recommended to utilize a rubber-band to secure the pH/ORP Cell Cap Seal to prevent loss of pH/ORP Storage Solution.

The sponge soaked with the pH/ORP Storage Solution in the pH/ORP Cell Cap Seal helps prolong the life of the pH/ORP module. It may be discarded if desired, but pH/ORP Storage Solution must be maintained in the unit cell at all times during non-use. Please fill the pH/ORP cell with 1 mL of Pyxis pH/ORP Storage Solution (P/N: 63900) at all times when not using the pH/ORP cell.



Figure 4. pH/ORP Cell Cap Seal in the open position

5.2 Control Keys

The SP-600 has three control keys, as shown in Figure 5. The left (), right (), and ok () keys are used to launch actions indicated on the LCD display directly above the keys. The labels above the keys indicate the function associated with each key and functions can be changed in different operation modes.

NOTE The LCD display is not a touch-enabled device.



Figure 5.

5.3 Main Module On/Off

To turn on the SP-600: Press **OK** momentarily and release.

To turn off the SP-600: Press and hold **OK** for about three seconds. Release **OK** when the LCD display turns off. The SP-600 turns itself off after 30 seconds without user interaction detected. This is done to conserve battery life.

NOTE This auto-time off setting may be customized by the user as desired through the **uPyxis® Mobile or Desktop App**.

5.4 pH/ORP Module On/Off

The pH/ORP module has a built-in Bluetooth chip. It can be turned on by the main SP-600 module via Bluetooth communication. The pH/ORP module will turn itself off when either commanded by the main module or automatically based on the idle time limit when main module is not in pH/ORP measurement mode.

6 Measurement

6.1 Switch Measurement Mode

The SP-600 has two major measurement modes: Conductivity mode (includes TDS, resistivity, and DPD free and total chlorine) and pH/ORP mode. The left (**<**) and right (**>**) keys are used to switch between the modes.

When powered on, the SP-600 defaults to Conductivity mode (Figure 6). "**Conductivity**", "**Temp**", and their measurement readings are in **bold**, while "pH" and "ORP" are in gray and their measurement values show "--". While in Conductivity mode, press **Cond** (**<**) to launch a selection menu (Figure 7). Press **Cond** (**<**) as needed to switch the device to alternate measurement options, then press **OK** to start the related measurement selected.

To switch from Conductivity mode to pH/ORP mode, press **pH/ORP** (**>**). "**pH**", "**ORP**", and their measurement readings will become **bold**, while "Conductivity", "Temp", and their measurement readings will become gray (Figure 8). While in pH/ORP mode, press **Cond** (**<**) to switch back to Conductivity mode.



Figure 6. Conductivity mode

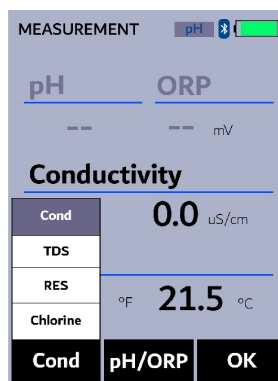

Figure 7. Cond alternate selection menu

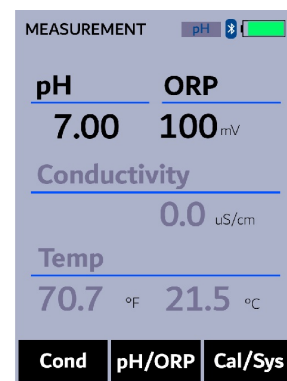

Figure 8. pH/ORP mode

6.2 Conductivity Measurement

6.2.1 Measurement Procedure

When powered on, the SP-600 will default to the Conductivity mode. If the SP-600 does not default start in this mode, follow the instructions in the **Switch Measurement Mode** section to switch back to Conductivity mode. A water sample should be transferred to the conductivity cell using a disposable pipette, or the cells can be filled slowly from a sample bottle.

NOTE *Special care should be taken when pouring the sample into the cell to avoid air bubble entrainment, which can interfere with reading accuracy.*

Before beginning a measurement, use the sample water to rinse the cell at least three times. Allow 5–10 seconds for the SP-600 to reach stabilize.

NOTE *The time required to reach a stable reading may be slightly longer if the water sample temperature is significantly different than the environmental temperature at which the SP-600 had been equilibrated (stored).*

6.2.2 Temperature Compensation

The displayed conductivity value is automatically compensated to the nominal value at the reference temperature 25 °C using the sample temperature measured. The commonly used linear correction equation is used:

$$\text{Conductivity at } 25\text{ }^{\circ}\text{C} = \frac{\text{Conductivity at } T_{\text{measured}}}{1 + 0.02(T_{\text{measured}} - 25)} \quad (1)$$

where T_{measured} is the sample temperature in °C. The default value of conductivity temperature compensating factor is 0.02 which means 2% per °C. This factor can be changed to be to any value between 0.00 %/°C – 9.99 %/°C via the **uPyxis®** App. Changing the factor to 0.00 %/°C will disable the temperature compensation.

6.3 Total Dissolved Solids (TDS) Measurement



The conversion ratio of TDS to conductivity is automatically compensated to the nominal value at the reference temperature 25 °C and is based on empirical industry standards. This ratio is pre-programmed into the SP-600 as the default value. The following table lists the default TDS ratio readings for four typical conductivity solutions:

Table 3.

Conductivity	TDS
50 μS/cm	31 ppm
500 μS/cm	336 ppm
5,000 μS/cm	4,041 ppm
50 mS/cm	57.09 ppt

6.3.1 Measurement Procedure

Follow the steps below to measure the TDS:

1. Press **Cond** () to switch the measurement mode to Conductivity mode.
2. Press **Cond** () as needed to highlight **TDS** in the selection menu (Figure 9).
3. Press  to start TDS measurement.
4. TDS values will be displayed in the same area the conductivity reading was previously displayed (Figure 10).

NOTE The TDS measurement will continue to be displayed until the user switches to an alternate measurement mode or conducts a power cycle of the SP-600.

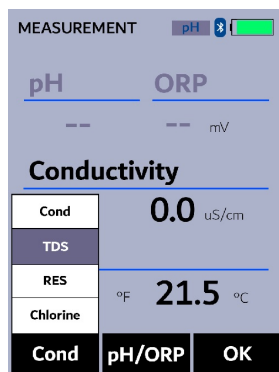

Figure 9. Highlight TDS measurement

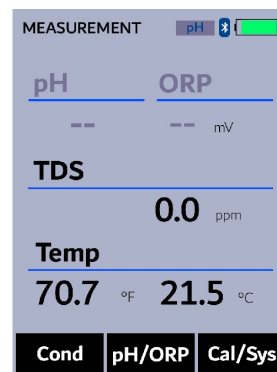

Figure 10. TDS measurement

6.3.2 TDS to Conductivity Ratio Adjustment

The SP-600 allows the user to set a custom TDS to conductivity conversion ratio within the range of 0.125 to 5. This ratio will be in effect in the full TDS measurement range when user checks the **User TDS Ratio** box in the **uPyxis®** App as shown in Figure 11.

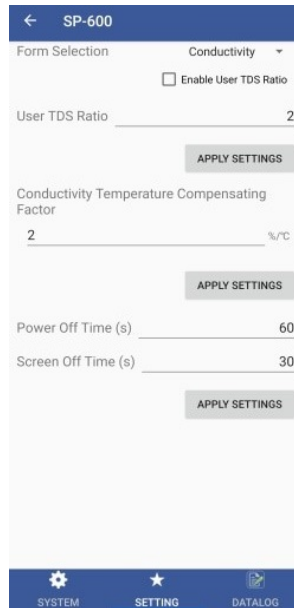





Figure 11. Setting User TDS Ratio in uPyxis® Mobile App

6.4 Resistivity Measurement

Resistivity is the reciprocal of conductivity, which is automatically compensated to the nominal value at the reference temperature 25 °C. Follow the steps below to measure the resistivity:

1. Press **Cond** () to switch the measurement mode to Conductivity mode.
2. Press **Cond** () as needed to highlight **RES** in the selection menu (Figure 12).
3. Press  to start resistivity measurement.
4. Resistivity values will be displayed in the same area the conductivity reading was previously displayed (Figure 13).

NOTE *The resistivity measurement will continue to be displayed until the user switches to an alternate measurement mode or conducts a power cycle of the SP-600.*

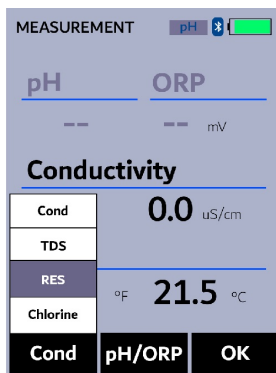

Figure 12. Highlight RES (resistivity) measurement

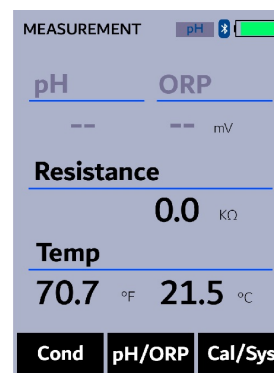









Figure 13. Resistivity measurement

6.5 DPD Free and Total Chlorine Measurement

The SP-600 free and total chlorine methods are based on the USEPA-accepted N, N-diethyl-p-phenylenediamine (DPD) chemistry. The free chlorine (CL-F) powder pillow reagent and total chlorine (CL-T) powder pillow reagent dissolve and react with free chlorine and total chlorine in the water sample to form a pink solution. The SP-600 measures the absorbance value of the resulted pink solution to determine the free chlorine and total chlorine concentration as DPD.

NOTE *Both Pyxis Lab DPD or HACH DPD 10 mL free and total chlorine reagent powder pillows may be used for this test method.*

Follow the steps below to measure free and total chlorine:

1. Press **Cond** () to switch the measurement mode to Conductivity mode.
2. Press **Cond** () as needed to highlight **Chlorine** in the selection menu (Figure 14).
3. Press  to launch the **SELECT METHOD** screen (Figure 15).
4. Use  and  to cycle to the desired chlorine method.
5. Press  to select the desired chlorine method and launch the **CHLORINE MEASUREMENT** screen (Figure 16).
6. Rinse the conductivity/chlorine sample cell three times with the sample to be tested. Fill the sample cell with the sample.
7. Press **Zero** (). **ZERO** will then appear on the top-left corner of the display.
8. Prepare the developed sample:
 - (a) Add 10 mL of the sample water into the 10 mL sample vial provided.
 - (b) Add one free chlorine or total chlorine powder pillow to the 10 mL sample vial (Figure 18).
 - (c) Cap the 10 mL sample vial and invert several times to fully mix the reagent and sample.
 - (d) The developed sample should be pink if either species of chlorine is present in the sample.
9. Use a portion of the developed sample to rinse the conductivity/chlorine sample cell once. Fill the sample cell with the remaining developed sample (Figure 19).
10. Press **Timer** (). A 1-minute timer for free chlorine or 3-minute timer for total chlorine will begin.
11. The SP-600 will continuously display the free or total chlorine concentration as the timer counts down. Record the final value after timer stops.

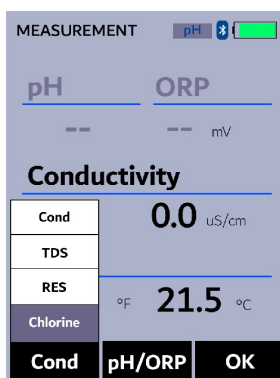

Figure 14. Highlight Chlorine measurement

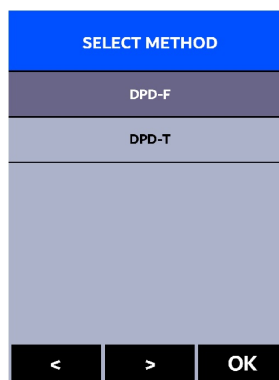

Figure 15. Select chlorine measurement method

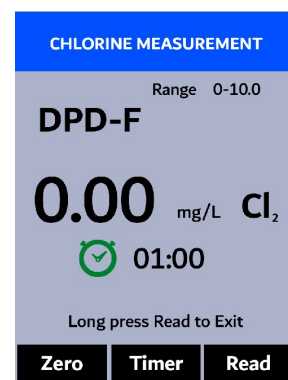

Figure 16. CHLORINE MEASUREMENT screen



Figure 17. Pyxis's free and total chlorine powder pillows



Figure 18. Add DPD powder to sample



Figure 19. Fill sample cell with developed sample

6.6 Temperature Measurement

The SP-600 has two platinum RTD's (Resistance Temperature Detectors), one located in the conductivity cell and one in the pH/ORP cell. These temperature sensors are individually calibrated in the Pyxis factory and do not need to be calibrated during use. The temperature values measured are used in the conductivity temperature compensation and in converting the measured cell potential to the pH value of the sample temperature. The temperature on the display is obtained from the conductivity cell RTD.

6.7 pH/ORP Measurement

6.7.1 Measurement Procedure

Follow the steps below to measure pH and ORP:

1. Press **pH/ORP** () to switch to the pH/ORP measurement mode. This will automatically power on the pH/ORP module. The indicator light of the module will be **green** and flashing when powered on. The main module of the SP-600 will automatically connect after the pH/ORP module has been powered up.
2. Once connected, the background color of **pH** indicator on top-right corner of the display will change from gray to **blue** and the indicator light on the pH/ORP module itself will be change from green to **blue** and flashing. The prompt message is also changed from **Connecting...** to **Measuring...**.
3. Once the measurements are completed, the values will be displayed and the prompt message will disappear.
4. Rinse the pH/ORP sample cell three times with the sample to be tested. Fill the sample cell with the sample.
5. The pH and ORP values will be updated every two seconds on the SP-600 main module display. The values will be displayed in white with a **blue background** once a stable value is reached (Figure 20).

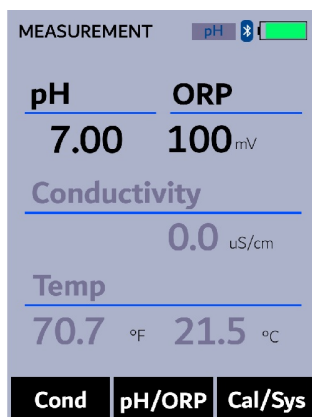

Figure 20. Display pH and ORP values

6.7.2 Erroneous Values

An erroneous pH value could be obtained if the module has been stored dry without the protection of pH/ORP Storage Solution for a long period of time. In this case, please fill the module cell with pH/ORP Storage Solution to wet the electrode and allow it to soak for 30 minutes before use. If the pH/ORP Storage Solution is not available, please use the sample water to hydrate the electrode for at least 30 minutes.

6.7.3 pH Measurement Principle

The SP-600 pH/ORP module uses the standard electrochemical cell for the pH measurement. The cell consists of a glass electrode and an Ag/AgCl reference electrode. Potassium chloride (KCl) electrolyte filling gel is sealed in the Ag/AgCl electrode. The amount of reference electrolyte in the pH/ORP module is significantly larger than that used in a common laboratory pH electrode. This reduces the chance of the filling solution being diluted or contaminated and increases the electrode life.

The pH value is calculated from the measured cell potential (EMF in mV):

$$pH = \frac{EMF}{S(T) + pH_o} \quad (2)$$

$$S(T) = 0.1986(T + 273.15) \quad (3)$$

$S(T)$ in the above equation is the calibration slope, where T is temperature in degrees Celsius. $S(T)$ has a theoretical value of 59.17 mV at 25 °C. pH_o is the calibration intercept. The calibration slope, $S(T)$, at the nominal temperature 25 °C and the intercept, pH_o , are determined in the two-point or three-point calibration procedure. pH_o is determined as well in the single-point pH 7.00 calibration. The temperature value measured by the pH/ORP module is used in the above equation to calculate the pH value at the sample temperature.

NOTE The temperature compensation involved in the pH value calculation is quite different from that in the conductivity measurement. The temperature-compensated conductivity value is a would-be value at the reference temperature 25 °C, while the pH value displayed by the SP-600 is the true pH value at the sample temperature.

6.7.4 ORP Measurement Principle

The SP-600 measures the sample ORP with the platinum electrode and the Ag/AgCl reference electrode in the pH/ORP cell. The pH measurement and the ORP measurement share the same reference electrode. **Reporting an ORP value without specifying the reference scale has no meaning.** The value displayed by the SP-600 depends on the ORP value of the ORP standard used in the calibration. If the ORP value of the standard is referenced to the Standard Hydrogen Electrode (SHE), the ORP value reported by the SP-600 is SHE-based, i.e., in the unit of Eh. If the ORP value of the standard is referenced to the Ag/AgCl (3M KCl) electrode, the ORP value reported by the SP-600 is referenced to the same, commonly noted as (Ag/AgCl, 3M KCl).

The ORP electrode is calibrated using the Zobell's standard using the value of 221 mV at 25 °C before shipping. **The default ORP scale of the SP-600 before a user calibration is the Ag/AgCl (3M KCl).** If the SP-600 is exposed to an extremely high (> +600 mV) or extremely low (< -200 mV) ORP sample, rinsing the pH/ORP cell excessively when switching to measure a lower or higher redox buffer capacity sample is necessary. The dissolved oxygen in the sample can contribute to the ORP value measured. To measure a sample that has not been equilibrated with the ambient air, a slow and small upward drifting to more positive ORP value is normal. For a typical cooling water sample treated with oxidizing biocides, a ± 20 mV accuracy and ± 10 mV precision can be expected.

7 Calibration

7.1 Conductivity Calibration

The conductivity and pH/ORP measurements can be calibrated separately using the corresponding standards.

7.1.1 Calibration Recommendation

A standard with conductivity value 10, 100, 1,000, 7,000, or 50,000 μS can be used to calibrate conductivity. The following table lists the recommended standard to calibrate the SP-600 according to the measurement range. Optionally, the user can use a standard with any conductivity value in the range of 800 to 7,000 μS , such as the commonly used 1,412 (or 1,413) μS standard, to calibrate the SP-600.

Table 4.

Measurement Range	Recommended Standard
0–60 μS	10 μS
60–500 μS	100 μS
500–2,000 μS	1,000 μS
2,000–10,000 μS	7,000 μS
10,000–200,000 μS	50,000 μS

7.1.2 Standard Calibration (10, 100, 1,000, 7,000, or 50,000 μS)

1. Rinse the conductivity sample cell three times with the desired conductivity standard. Fill the sample cell with the standard.
2. Power on the SP-600 by pressing **OK**. Allow 5–10 seconds for the SP-600 to stabilize.
3. Press **Cal/Sys** (**OK**) to launch the **DEVICE INFORMATION** screen.
4. Press **Calib** (**>**) as needed to highlight **Cond** (conductivity) calibration in the selection menu (Figure 21).
5. Press **OK** to launch the **CONDUCTIVITY CALIBRATION** screen.
6. Use **<** and **>** to cycle to the desired calibration, for example, 1,000 μS (Figure 22). The standard conductivity selections are 10, 100, 1,000, 7,000, and 50,000 μS .

NOTE To exit the calibration procedure entirely, long press **Calib** (**OK**)

7. Press **Calib** (**OK**) to confirm the specific conductivity calibration desired.
8. The display updates as shown in Figure 23 and the user can choose one of three options:
 - (a) Press **OK** to start the calibration, or
 - (b) Press **Cancel** (**<**) to return to the **CONDUCTIVITY CALIBRATION** screen, or
 - (c) Press **Exit** (**>**) to abandon calibration entirely.
9. Once calibration begins, the SP-600 reads the sample and displays the value in the **Measured** section. A slight variance from the target is acceptable.
10. The message “**Calibration Success**” will appear towards the bottom of the display (Figure 24).
11. Calibration is now complete, long press **Calib** (**OK**) to return to Conductivity mode.

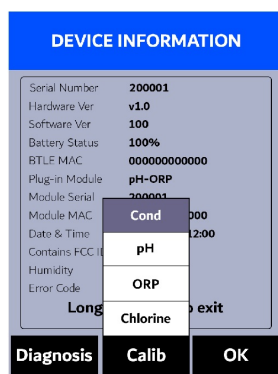

Figure 21.



Figure 22.

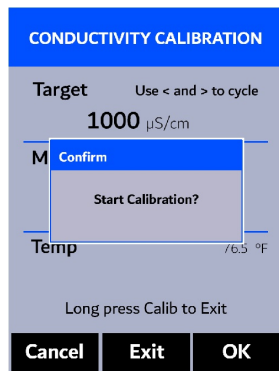

Figure 23.



Figure 24.

7.1.3 User-Defined Calibration

1. Rinse the conductivity sample cell three times with the desired conductivity standard. Fill the sample cell with the standard.
2. Power on the SP-600 by pressing **OK** . Allow 5–10 seconds for the SP-600 to stabilize.
3. Press **Cal/Sys** (**OK**) to launch the **DEVICE INFORMATION** screen.
4. Press **Calib** (**>**) as needed to highlight **Cond** (conductivity) calibration in the selection menu (Figure 25).
5. Press **OK** to start the calibration procedure.
6. Press **<** to select the **USER DEFINED CALIBRATION** screen (Figure 26).
7. Use **-** (**<**) and **+** (**>**) to adjust the target conductivity value as desired. Holding a key down scrolls the values at a faster rate.
8. Press **Set** (**OK**) to confirm the target conductivity value.

NOTE To exit the calibration procedure entirely, long press **Calib** (**OK**)
9. Press **Calib** (**OK**) to confirm the specific conductivity calibration desired.
10. The display updates as shown in Figure 27 and the user can choose one of three options:
 - (a) Press **OK** to start the calibration, or
 - (b) Press **Cancel** (**<**) to return to the **CONDUCTIVITY CALIBRATION** screen, or
 - (c) Press **Exit** (**>**) to abandon calibration entirely.
11. Once calibration begins, the SP-600 reads the sample and displays the value in the **Measured** section. A slight variance from the target is acceptable.
12. The message “**Calibration Success**” will appear towards the bottom of the display (Figure 28).
13. User-Defined Calibration is now complete, long press **Calib** (**OK**) to return to Conductivity mode.

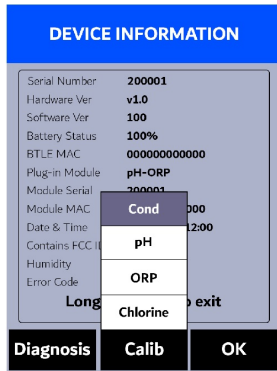

Figure 25.

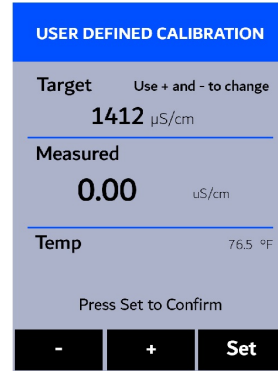

Figure 26.

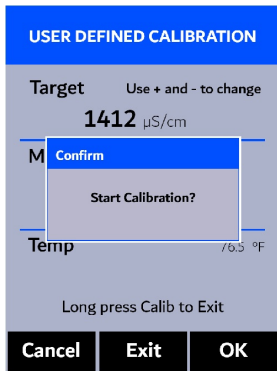

Figure 27.

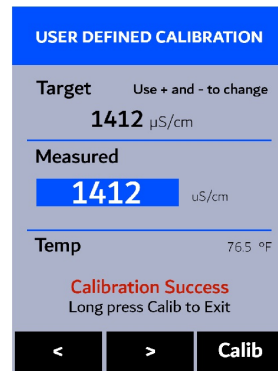

Figure 28.

7.2 DPD Free and Total Chlorine Calibration

7.2.1 Calibration Check using Pyxis DPD Chlorine Secondary Standard



Figure 29. DPD Chlorine Secondary Standard 1 ppm

The DPD Chlorine method has been calibrated prior to shipping; there is no need to calibrate unless a calibration check indicates that the method needs to be re-calibrated. The following steps are used to carry out a calibration check using a Pyxis DPD Chlorine Secondary Standard (either 1.0 ppm or 2.0 ppm):

1. Fill the conductivity/chlorine sample cell with the DPD Chlorine Secondary Standard solution and allow to soak for 15 minutes.

NOTE *This solution not only serves as a secondary calibration standard, but also as a sample cell cleaner having a pH of 4.0.*

2. After 15 minutes of soaking, use a pipe-cleaner brush or Q-Tip to gently clean the internal walls of the sample cell.
3. Rinse the sample cell three times with deionized (DI) water. Fill the sample cell with DI water.
4. Power on the SP-600 by pressing **OK** . Allow 5–10 seconds for the SP-600 to stabilize.
5. Press **Cond** (**<**) as needed to highlight **Chlorine** in the selection menu (Figure 30).
6. Press **OK** to launch the **CHLORINE MEASUREMENT** screen.
7. Press **Zero** (**<**). **ZERO** will appear on the top-left corner of the display.
8. Rinse the conductivity/chlorine sample cell three times with the Pyxis DPD Chlorine Secondary Standard solution. Fill the sample cell with the standard.
9. Press **Read** (**OK**) and record the value.
10. If the measured chlorine value is outside the standard value range in the certificate provided with the DPD Chlorine Secondary Standard, either:
 - (a) Follow the procedure in the **Slope Calibration using Pyxis DPD Chlorine Secondary Standard** section, or
 - (b) Follow the procedure in the **Slope Calibration using User-Defined DPD Chlorine Standard** section, or
 - (c) Contact service@pyxis-lab.com for pricing on factory calibration services.

7.2.2 Blank (Zero) Calibration

The DPD Chlorine method has a non-zero intercept value in the calibration equation. A proper non-zero intercept value has been calibrated prior to shipping. The following steps are used to carry out a reagent blank calibration which changes this non-zero intercept value:

1. Power on the SP-600 by pressing **OK** . Allow 5–10 seconds for the SP-600 to stabilize.
2. Press **Cal/Sys** (**OK**) to launch the **DEVICE INFORMATION** screen.
3. Press **Calib** (**>**) as needed to highlight **Chlorine** calibration in the selection menu (Figure 30).
4. Press **OK** to launch the **CHLORINE CALIBRATION** screen (Figure 31).
5. Press **Blank** (**<**) to start the blank (zero) calibration.
6. Rinse the conductivity/chlorine sample cell three times with deionized (DI) water. Fill the sample cell with DI water.
7. Press **Zero** (**<** or **>**). The message **"Zero Succeed"** will appear on the bottom of the display (Figure 32).
8. Prepare the developed blank-zero sample:
 - (a) Add 10 mL of DI water into the 10 mL sample vial provided.
 - (b) Add one free chlorine to the 10 mL sample vial.
 - (c) Cap the 10 mL sample vial and invert several times to fully mix the reagent and DI water.
 - (d) The developed blank-zero sample is now ready for measurement.
9. Use a portion of the blank-zero sample to rinse the conductivity/chlorine sample cell once. Pour the remaining blank-zero sample into the sample cell.
10. Press **Timer** (**<** or **>**). A 120-second timer will begin. The SP-600 will continuously display the chlorine concentration as the timer counts down.
11. After the timer stops, press **Calib** (**<** or **>**).
12. The message **"Blank calibration success"** will appear on the bottom of the display (Figure 33).
13. Blank calibration is complete. Press **Return** to return to the **CHLORINE CALIBRATION** screen.

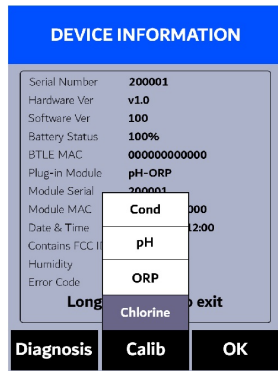

Figure 30.

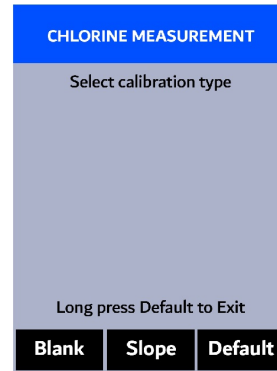

Figure 31.

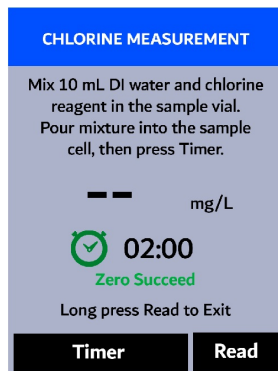

Figure 32.

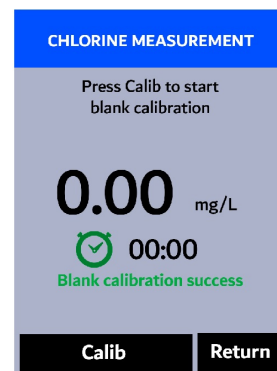

Figure 33.

7.2.3 Slope Calibration using Pyxis DPD Chlorine Secondary Standard

The DPD Chlorine method has been calibrated prior to shipping; there is no need to calibrate unless a calibration check (see the **Calibration Check using Pyxis DPD Chlorine Secondary Standard** section) indicates that the method needs to be re-calibrated. The following steps are used to carry out a slope calibration using the Pyxis DPD Chlorine Secondary Standard (1.0 ppm):

1. Power on the SP-600 by pressing **OK**. Allow 5–10 seconds for the SP-600 to stabilize.
2. Press **Cal/Sys** (**OK**) to launch the **DEVICE INFORMATION** screen.
3. Press **Calib** (**>**) as needed to highlight **Chlorine** calibration in the selection menu (Figure 34).
4. Press **OK** to launch the **CHLORINE CALIBRATION** screen (Figure 35).
5. Press **Slope** (**>**).
6. Use **<** and **>** to cycle to the desired secondary standard (Figure 36).
7. Press **OK** to start the slope calibration using Pyxis DPD Chlorine Secondary Standard.
8. Rinse the conductivity/chlorine sample cell three times with deionized (DI) water. Fill the sample cell with DI water.
9. Press **Zero** (**<** or **>**). The message **"Zero Succeed"** will appear on the bottom of the display (Figure 37).
10. Rinse the conductivity/chlorine sample cell three times with Pyxis DPD Chlorine Secondary Standard. Fill the sample cell with the standard.
11. Press **Read** (**<** or **>**).
12. Press **Calib** (**<** or **>**). The message **"Slope calibration success"** will appear on the bottom of the display (Figure 38).
13. Slope calibration is complete. Press **Return** (**OK**) to return to the **CHLORINE CALIBRATION** screen.

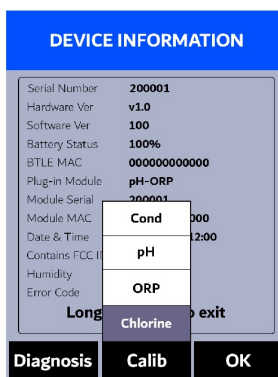

Figure 34.

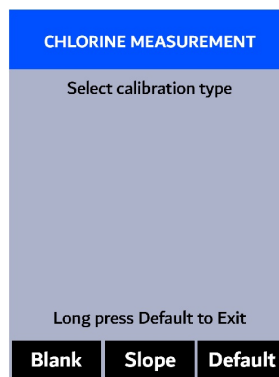

Figure 35.

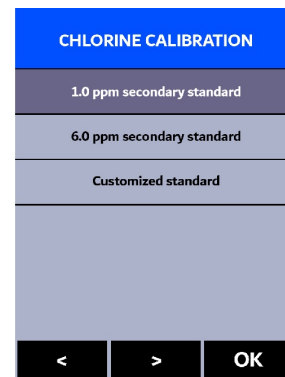

Figure 36.

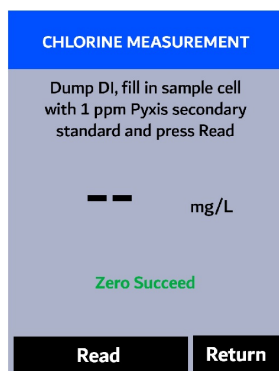

Figure 37.

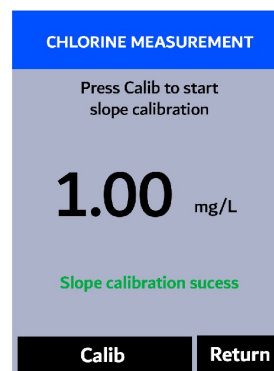









Figure 38.

7.2.4 Slope Calibration using User-Defined DPD Chlorine Standard

The DPD Chlorine method has been calibrated prior to shipping; there is no need to calibrate unless a calibration check (see the **Calibration Check using Pyxis DPD Chlorine Secondary Standard** section) indicates that the method needs to be re-calibrated. The following steps are used to carry out a slope calibration using a solution of known free or total chlorine concentration:

NOTE *It is recommended to have a chlorine concentration between 1.0 ppm and 2.0 ppm.*

1. Power on the SP-600 by pressing **OK** . Allow 5–10 seconds for the SP-600 to stabilize.
2. Press **Cal/Sys** (**OK**) to launch the **DEVICE INFORMATION** screen.
3. Press **Calib** (**>**) as needed to highlight **Chlorine** calibration in the selection menu (Figure 39).
4. Press **OK** to launch the **CHLORINE CALIBRATION** screen (Figure 40).
5. Press **Slope** (**>**).
6. Use **<** and **>** to cycle to "Customized standard" (Figure 41).
7. Press **OK** to start the slope calibration using Pyxis DPD Chlorine Secondary Standard.
8. Rinse the sample cell three times with the known chlorine solution. Fill the sample cell with the solution.
9. Press **Zero** (**<** or **>**). The message "**Zero Succeed**" will appear on the bottom of the display (Figure 42).
10. Prepare the developed standard:
 - (a) Add 10 mL of the known chlorine solution into the 10 mL sample vial provided.
 - (b) Add one free chlorine or total chlorine powder pillow to the 10 mL sample vial.
 - (c) Cap the 10 mL sample vial and invert several times to fully mix the reagent and sample.
 - (d) The developed standard should be pink if either species of chlorine is present in the sample.

11. Use a portion of the developed standard to rinse the conductivity/chlorine sample cell once. Pour the remaining developed standard into the sample cell.
12. Press **Timer** ( or ). A 120-second timer will begin. The SP-600 will continuously display the chlorine concentration as the timer counts down.
13. After the timer stops, press **Calib** ( or ).
14. Use - () and + () to adjust the chlorine concentration to the value of the known chlorine solution.
15. Press **Calib** (). The message “**Slope calibration success**” will appear on the bottom of the display (Figure 43).
16. Slope calibration is complete. Press **Return** () to return to the **CHLORINE CALIBRATION** screen.

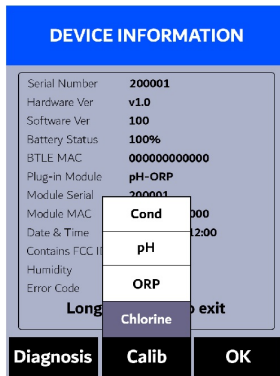

Figure 39.

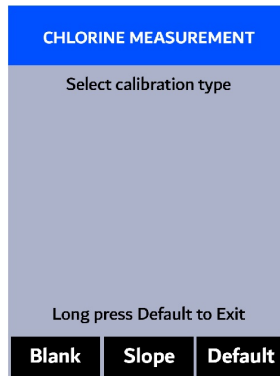

Figure 40.

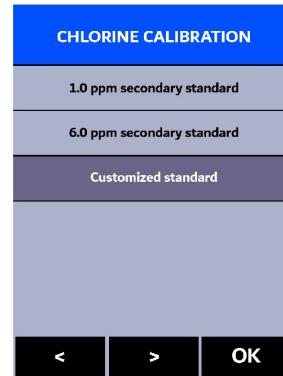

Figure 41.

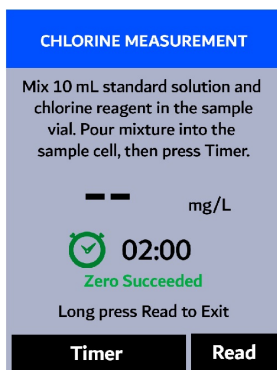



Figure 42.



Figure 43.

7.2.5 Restore Default Chlorine Calibration Parameters

Pressing the **Default** () during any of the chlorine calibration procedures will copy the default calibration intercept and slope to the working intercept and slope, respectively. This button action is to restore the working calibration parameters to the original, factory-loaded calibration parameters for both free and total chlorine.

7.3 pH Calibration

The SP-600 is designed to provide a flexible calibration procedure. The user can start with the one-point pH7 calibration and progressively add a two- and three-point calibration with the pH4 and pH10 buffers. This allows the user to choose a procedure based on the need of measurement accuracy and the target pH range. Follow the steps below to conduct either a one-point, two-point, or three-point pH calibration:

1. Power on the SP-600 by pressing **OK**.
2. Press **pH/ORP** (**>**) to switch to the pH/ORP measurement mode. This will automatically power on the pH/ORP module. The indicator light of the module will be **green** and flashing when powered on. The main module of the SP-600 will automatically connect after the pH/ORP module has been powered up.
3. Once connected, the background color of **pH** indicator on top-right corner of the display will change from gray to **blue** and the indicator light on the pH/ORP module itself will be change from green to **blue** and flashing. The prompt message is also changed from **Connecting...** to **Measuring...**.
4. Once the measurements are completed, the values will be displayed and the prompt message will disappear (Figure 44).
5. Press **Cal/Sys** (**OK**) to launch the **DEVICE INFORMATION** screen.
6. Press **Calib** (**>**) as needed to highlight **pH** calibration in the selection menu (Figure 45).
7. Press **OK** to start the calibration procedure.



Figure 44.

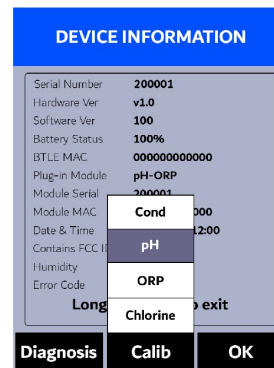

Figure 45.

7.3.1 One-Point Calibration

8. Rinse the pH/ORP sample cell three times with the pH7 buffer. Fill the sample cell with the pH7 buffer.
9. Allow 5–10 seconds for the pH measurement to stabilize and the padlock (🔒) to appear.
10. Press **pH7** (⏪ or ⏩) to start a one-point calibration.
11. If the calibration succeeds, a checkmark (✔) and a "pH7 Calibration success!" message will appear (Figure 46). Otherwise, a warning message is displayed.
12. After a successful one-point calibration, choose one of two options:
 - (a) Press **Next** (⏪ or ⏩) to proceed to a two- or three-point calibration, or
 - (b) Press **Exit** (OK) to end the calibration process at a one-point calibration.

7.3.2 Two-Point Calibration

13. Choose either the pH4 or pH10 buffer for a two-point calibration.
14. Rinse the pH/ORP sample cell three times with the chosen buffer. Fill the sample cell with the chosen buffer.
15. Allow 5–10 seconds for the pH measurement to stabilize and the padlock (🔒) to appear.
16. Press **Calib** (⏪ or ⏩) to start a two-point calibration.
17. If the calibration succeeds, a checkmark (✔) and a "pH4 Calibration success!" or a "pH10 Calibration success!" message will appear (Figure 47). Otherwise, a warning message is displayed.
18. After a successful two-point calibration, choose one of two options:
 - (a) Press **Next** (⏪ or ⏩) to proceed to a three-point calibration, or
 - (b) Press **Exit** (OK) to end the calibration process at a two-point calibration.

7.3.3 Three-Point Calibration

19. Use the remaining buffer (either the pH4 or pH10) for a three-point calibration.
20. Rinse the pH/ORP sample cell three times with the remaining buffer. Fill the sample cell with the remaining buffer.
21. Allow 5–10 seconds for the pH measurement to stabilize and the padlock (🔒) to appear.
22. Press **Calib** (⏪ or ⏩) to start a three-point calibration.
23. If the calibration succeeds, a checkmark (✔), a "pH4 Calibration success!" or a "pH10 Calibration success!" message, and a "Completed!" message will appear (Figure 48). Otherwise, a warning message is displayed.
24. After a successful three-point calibration, press **Exit** (⏪, ⏩, or OK) to return to pH/ORP mode.

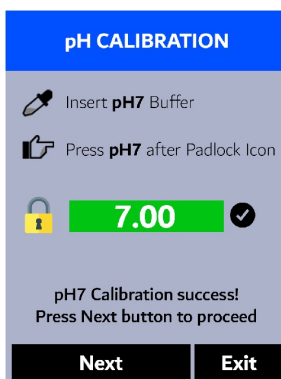

Figure 46.

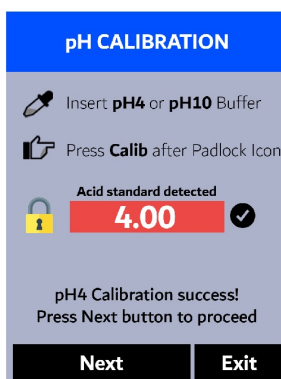

Figure 47.

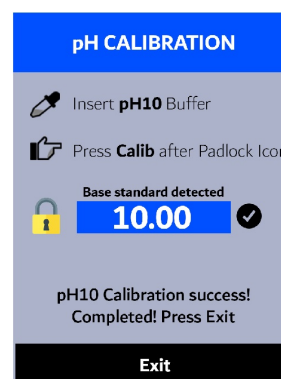

Figure 48.

7.4 ORP Calibration

The ORP scale of the SP-600 depends on the ORP scale of the calibration standard. For example, if the value of 220 mV for the common Zobell’s standard at 25 °C is entered in the above calibration, the ORP value reported by the SP-600 after calibration is referenced to the Ag/AgCl(3M KCl) scale. This is because the value of 220 mV is based on the Ag/AgCl(3M KCl) reference electrode. If the value entered in the above calibration is 429 mV, the ORP value reported by the SP-600 is referenced to the SHE, because the value of 429 mV at 25 °C for the Zobell’s standard is SHE based.

The values in the following table can be used to convert the Ag/AgCl reference electrode-based ORP value to the SHE-based ORP value. To obtain the SHE-based ORP value, add the number in the table to the corresponding Ag/AgCl reference electrode-based value. To use the table, the temperature of the standard solution measured by the SP-600 must be used.

Table 5.

Temperature °F (°C)*	Ag/AgCl (1M KCl)	Ag/AgCl (3M KCl)	Ag/AgCl (saturation KCl)
68 (20)	+234	+213	+202
77 (25)	+231	+209	+199
86 (30)	+228	+205	+196

* Use the temperature measured by the SP-600.

Follow the steps below to carry out an ORP calibration:

1. Power on the SP-600 by pressing **OK**.
2. Press **pH/ORP** (**>**) to switch to the pH/ORP measurement mode. This will automatically power on the pH/ORP module. The indicator light of the module will be **green** and flashing when powered on. The main module of the SP-600 will automatically connect after the pH/ORP module has been powered up.
3. Once connected, the background color of **pH** indicator on top-right corner of the display will change from gray to **blue** and the indicator light on the pH/ORP module itself will be change from green to **blue** and flashing. The prompt message is also changed from **Connecting...** to **Measuring...**.
4. Once the measurements are completed, the values will be displayed and the prompt message will disappear (Figure 49).
5. Press **Cal/Sys** (**OK**) to launch the **DEVICE INFORMATION** screen.
6. Press **Calib** (**>**) as needed to highlight **ORP** calibration in the selection menu (Figure 50).
7. Press **OK** to launch the **ORP CALIBRATION** screen (Figure 51).
8. Use **+** (**<**) and **-** (**>**) to adjust the ORP value to match the ORP standard used.
9. Press **Calib** (**OK**). The message **"Calibration Success"** will appear on the display (Figure 52).
10. ORP calibration is complete. Long press **Calib** (**OK**) to return to pH/ORP mode.



Figure 49.

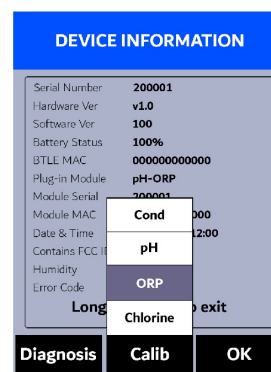

Figure 50.

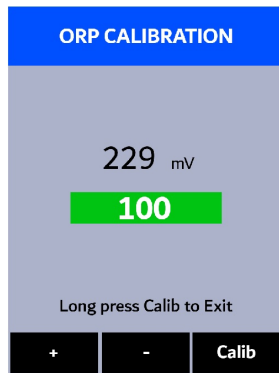

Figure 51.

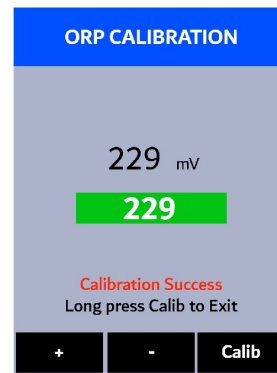

Figure 52.

8 Device Information and Diagnosis

The **DEVICE INFORMATION** screen is launched when **Cal/Sys** (OK) is pressed in either the Conductivity or pH/ORP measurement mode. This screen contains the device serial number, software version, and hardware version (Figure 53). The battery life as a percentage and the MAC addresses for main module and pH/ORP module (after pair) are also shown.

Press **Diagnosis** (←) to launch the **SYSTEM DIAGNOSIS** screen where raw measurement data are displayed (Figure 54). The information has no use for normal operation, but instead is used for device troubleshooting. Provide an image of both the **DEVICE INFORMATION** screen and the **SYSTEM DIAGNOSIS** screen when you contact Pyxis (service@pyxis-lab.com) for troubleshooting your device or call +1 (866) 203-8397.

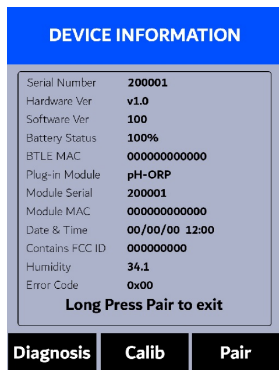

Figure 53.



Figure 54.

8.1 Conductivity/Chlorine Sample Cell Cleanliness Check

The SP-600 is designed to provide reliable and accurate measurement on DPD Free and Total Chlorine. Heavy fouling will prevent the light from reaching the sensor, resulting in inaccurate readings. It is suggested that the SP-600 be checked for fouling and cleaned on a monthly basis. Heavily contaminated waters may require more frequent cleanings. Cleaner water sources with less contamination may not require cleaning for several months. The SP-600 is designed to carry out a Cleanliness Check as described below:

1. Power on the SP-600 by pressing **OK**.
2. Press **Cal/Sys** (**OK**) to launch the **DEVICE INFORMATION** screen.
3. Press **Diagnosis** (**<**) to launch the **SYSTEM DIAGNOSIS** screen.
4. Press **Cleanliness** (**<**). An instruction prompt appears to ask the user to put DI water into the conductivity/chlorine sample cell (Figure 55).
5. Pour DI water into the conductivity/chlorine sample cell.
6. Press **Confirm** (**<**, **>**, or **OK**). The instruction prompt will disappear and the SP-600 displays a countdown toward the bottom of the display.
7. Once the Cleanliness Check is completed a **Clean** message (Figure 56) or **Sample cell fouled** message (Figure 57) will appear towards the bottom of the display.
8. Press **Exit** (**OK**) to return to the **DEVICE INFORMATION** screen.

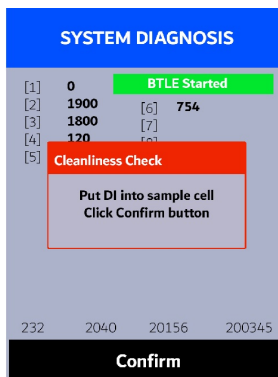

Figure 55.



Figure 56.

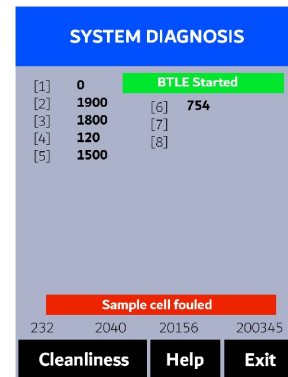

Figure 57.

8.2 Bluetooth Connection to Devices

The SP-600 uses a built-in Bluetooth Low Energy Connection (BTLE) to connect wirelessly to a smart phone via the **uPyxis®** Mobile App or to a computer via the included Bluetooth Adapter (P/N: MA-NEB) and the **uPyxis®** Desktop App. To allow the SP-600 to connect via Bluetooth with other devices follow the steps below:

1. Power on the SP-600 by pressing **OK**.
2. Press **Cal/Sys** (**OK**) to launch the **DEVICE INFORMATION** screen.
3. Press **Diagnosis** (**<**) to launch the **SYSTEM DIAGNOSIS** screen.
4. Allow 5–10 seconds for the message in the top-right corner of the display change from **Starting BTLE...** to **BTLE Started** (Figure 54).
5. Choose to connect via one of two options:
 - (a) The **uPyxis®** Mobile App (see the **Use with uPyxis® Mobile App** section), or
 - (b) The **uPyxis®** Desktop App (see the **Use with uPyxis® Desktop App** section).

8.3 Factory Reset

Use the following steps to restore all device parameters to factory default:

1. Power on the SP-600 by pressing **OK**.
2. Press **Cal/Sys** (**OK**) to launch the **DEVICE INFORMATION** screen.
3. Press **Diagnosis** (**<**) to launch the **SYSTEM DIAGNOSIS** screen.
4. Allow 5–10 seconds for the message in the top-right corner of the display change from **Starting BTLE...** to **BTLE Started**.
5. Press **Help** (**>**) to launch the **HELP** screen (Figure 58).
6. Press **Factory Reset** (**<** or **>**). The display updates as shown in Figure 59 appear and the user can choose one of three options:
 - (a) Press **OK** to start the factory reset, or
 - (b) Press **Cancel** (**<**) to return to the **HELP** screen, or
 - (c) Press **Exit** (**>**) to abandon the factory reset entirely.
7. After a successful factory reset, the message “Factory reset done.” will appear on the display.
8. Press **Exit** (**OK**) to return to Conductivity mode.



Figure 58.



Figure 59.

9 Use with uPyxis® Mobile App

9.1 Download uPyxis® Mobile App

Download uPyxis® Mobile App from [Apple App Store](#) or [Google Play](#).



Figure 60.

9.2 Connecting to uPyxis® Mobile App

Connect the SP-600 to a mobile smart phone according to the following steps:

1. Follow the steps in the **Bluetooth Connection to Devices** section to make the SP-600 discoverable.
2. Open **uPyxis®** Mobile App.
3. On **uPyxis®** Mobile App, pull down to refresh the list of available Pyxis devices.
4. If the connection is successful, the SP-600 and its Serial Number (SN) will be displayed (Figure 61).
5. Press on the **SP-600 image**.

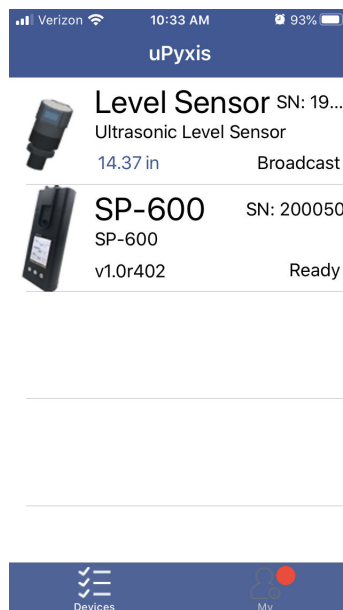

Figure 61.

9.3 System Screen

When connected, the uPyxis® Mobile App will default to the **System** screen. From the **System** screen, users can change the **Device Name**, find the **Serial Number**, **Hardware Version**, and **Firmware Version**, as well as update the firmware of the SP-600 by pressing **Check Update**. If a firmware update is available, press **Get Firmware**. Once the new firmware is downloaded, press **Upgrade Firmware**.

NOTE *The firmware update process takes some time and will require the SP-600 to stay within range (approximately 10 ft without obstructions) for the entire duration of the update.*

Once the update is complete, the SP-600 will reboot which will disconnect the SP-600 from the uPyxis® Mobile App.

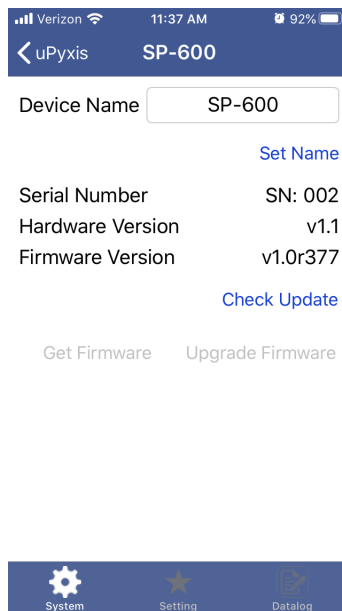

Figure 62.

9.4 Setting Screen

From the **Setting** screen, the user can enable and set a **User defined Total Dissolved Solids (TDS) ratio** and set the **Conductivity Temperature** compensation. For more information about the user-defined TDS ratio, see the **TDS to Conductivity Ratio Adjustment** section. For more information about the conductivity temperature compensation, see the **Temperature Compensation** section. The user can also set the **Power off time** and **Screen off time** in seconds.

Verizon 11:37 AM 91%

< uPyxis SP-600

Form Selection Conductivity

Enable user defined TDS ratio

User defined TDS ratio 0.67

Conductivity Temperature

2 %/°C

Apply Settings

Settings

Power off time 1... (s)

Screen off time 30 (s)

Apply Settings

System Setting Datalog

Figure 63.

9.5 Datalog Screen

From the **Datalog** screen, the user can view and export the internal log files of the SP-600 by pressing **Read Datalogs** and selecting the desired datalog (these are separated by month). The SP-600 will then populate any relevant log event from the selected datalog which can be viewed in more detail by pressing **Read Record** or exported as a CSV document by pressing **Export/Share**.



Figure 64.

10 Use with uPyxis® Desktop App

10.1 Install uPyxis® Desktop App

Download the latest version of uPyxis® Desktop software package from: <http://www.pyxis-lab.com/support.html> this setup package will download and install the Microsoft.Net Framework 4.5 (if not previously installed on the PC), the USB driver for the USB-Bluetooth adapter (MA-NEB), the USB-RS485 adapter (MA-485), and the main uPyxis® Desktop application. Double click the **uPyxis.Setup.exe** file to install.

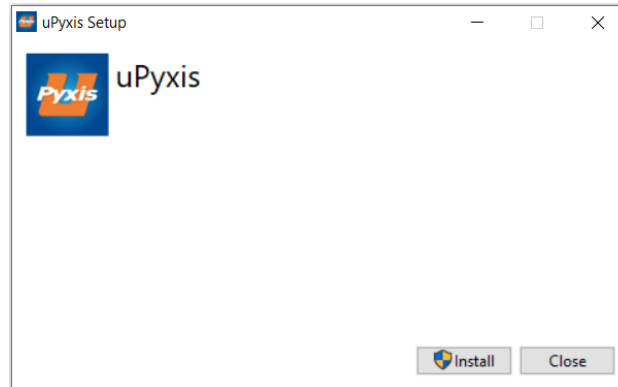

Figure 65.

Click **Install** to start the installation process. Follow the screen instructions to complete the USB driver and uPyxis installation.

10.2 Connecting to uPyxis® Desktop App

Connect the SP-600 to a Windows computer using a Bluetooth/USB adapter (P/N: MA-NEB) according to the following steps:

1. Follow the steps in the **Bluetooth Connection to Devices** section to make the SP-600 discoverable.
2. Plug the Bluetooth/USB adapter into a USB port in the computer.
3. Launch **uPyxis®** Desktop App.
4. On **uPyxis®** Desktop App, click Device → **Connect via USB-Bluetooth** (Figure 66).
5. If the connection is successful, the SP-600 and its Serial Number (SN) will be displayed in the left pane of the **uPyxis®** window.

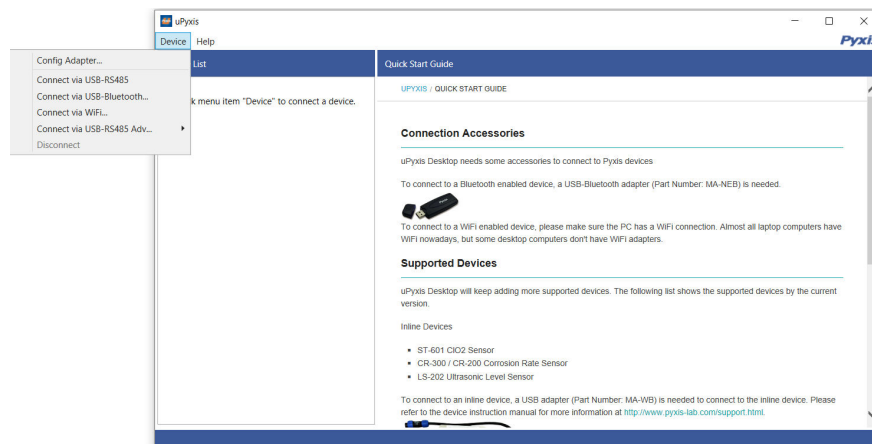

Figure 66.

10.3 System Screen

Once connected to the device, a picture of the device will appear on the top-left corner of the window and the **uPyxis**® Desktop App will default to the **System** screen. From the **System** screen, users can upgrade the firmware by selecting an appropriate firmware file (contact service@pyxis-lab.com for these firmware files) and clicking **Upgrade Firmware**.

NOTE *The firmware update process takes some time and will require the SP-600 to stay within range (approximately 10 ft without obstructions) for the entire duration of the update.*

Once the update is complete, the SP-600 will reboot which will disconnect the SP-600 from the **uPyxis**® Mobile App.

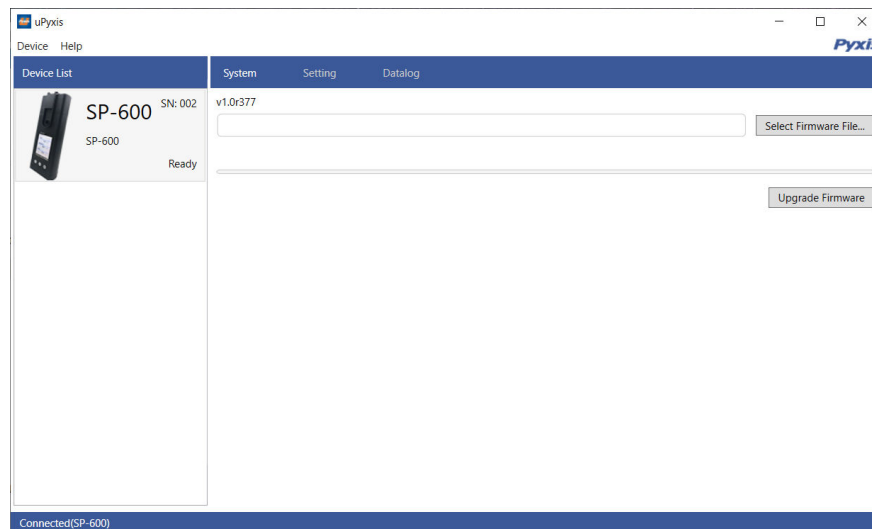

Figure 67.

10.4 Setting Screen

From the **Setting** screen, the user can enable and set a **User defined Total Dissolved Solids (TDS) ratio** and set the **Conductivity Temperature** compensation. For more information about the user-defined TDS ratio, see the **TDS to Conductivity Ratio Adjustment** section. For more information about the conductivity temperature compensation, see the **Temperature Compensation** section. The user can also set the **Power off time** and **Screen off time** in seconds.

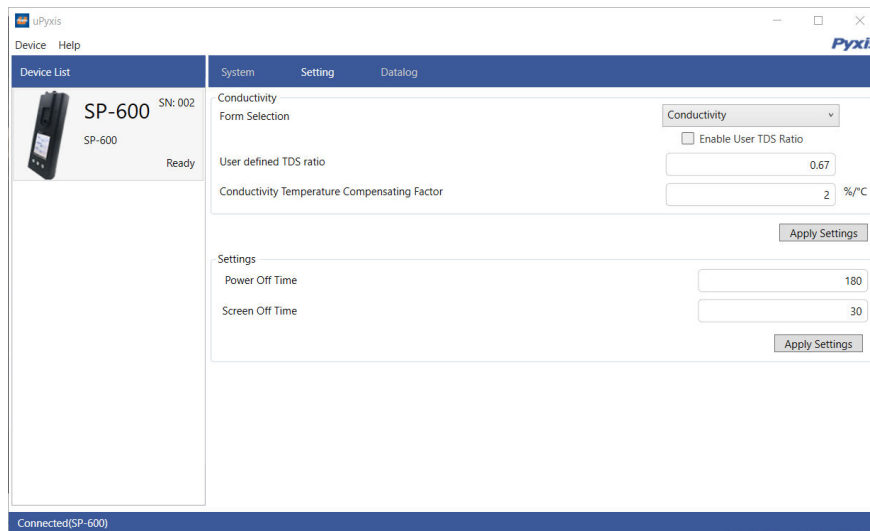

Figure 68.

10.5 Datalog Screen

From the **Datalog** screen, the user can view, delete, and export the internal log files of the SP-600 by clicking [Read Datalog List](#) and selecting the desired datalog (these are separated by month). The SP-600 will then populate any relevant log event from the selected datalog which can be viewed in more detail by clicking [Read Datalog](#), deleted by clicking [Delete](#), or exported by clicking [Export as .CSV File](#).

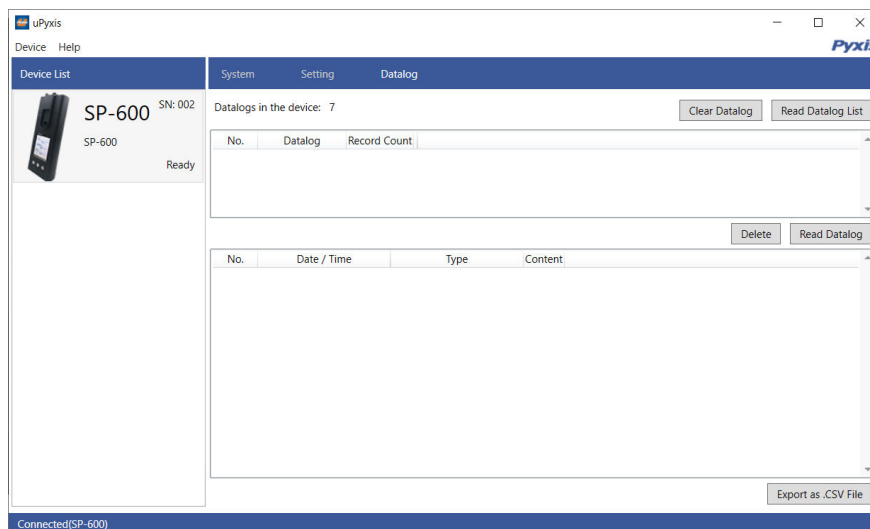

Figure 69.

11 Device Maintenance and Precaution

11.1 Maintenance Best Practices

For greatly increased working life of the SP-600 follow the list of maintenance best practices below:

- Rinse the SP-600 with tap water or DI water after measurement and remove residual water using a paper towel.
- Maintain 1 mL of pH/ORP Storage Solution in the pH/ORP cell at all times when the SP-600 is not being used.
- Close the pH/ORP Cell Cap Seal firmly to keep the pH/ORP cell wet. Use rubber-band to ensure cell cap remains closed for aggressive handling.
- On a monthly basis, or as needed, conduct a chemical cleaning using Pyxis SER-02 Handheld Cleaning Solution of the conductivity/chlorine cell to remove deposition or film development.
- Use a Q-tip to gently clean the inside of the conductivity/chlorine cell to remove any deposits that may have attached to the optical and electrode surfaces.
- Completely soak the conductivity/chlorine cell for one hour before a measurement if the SP-600 has not been used in more than two weeks.
- Do not expose the SP-600 to an extreme high or low temperature condition such as leaving the SP-600 inside an unattended automobile. The pH electrode can survive a few short exposures to 0 °F (-18 °C) or 140 °F (60 °C), but repeated extreme low and high temperature cycling will damage the pH electrode.

11.2 Methods to Cleaning the SP-600

A light deposit on quartz glass inside the conductivity cell can be cleaned by a Q-tip. Aged heavy deposition, especially iron oxide deposited, can be removed using a cleaning solution that is capable of removing iron, such as the Pyxis Handheld Device Cleaning Solution Kit (P/N: SER-02) available from Pyxis online eStore/Catalog <https://pyxis-lab.com/product/handheld-device-cleaning-kit/>.



Figure 70. Handheld Device Cleaning Solution Kit

To clean the SP-600 pour cleaning solution into the conductivity/chlorine cell for 10 minutes. Rinse the cell with distilled water and use the Cleanliness Check (see the **Conductivity/Chlorine Sample Cell Cleanliness Check** section) to confirm that the SP-600 is clean. Repeat the process as needed until the Cleanliness Check shows **Clean**.

11.3 Storage

When the pH/ORP cell is not in use, fill the cell with 1 mL of Pyxis pH/ORP Storage Solution (P/N: 63900) and ensure the pH/ORP Cell Cap Seal is closed completely. The pH/ORP Cell Cap Seal seals the pH/ORP cell, maintaining a moist environment for the electrodes. For vigorous field use, it is recommended to utilize a rubber-band to secure the pH/ORP Cell Cap Seal to prevent loss of pH/ORP Storage Solution.

Do not expose the SP-600 to an extreme high or low temperature condition such as leaving the SP-600 inside an unattended automobile.

NOTE Repeated extreme low and high temperature cycling will damage the pH electrode.

11.4 pH/ORP Module Replacement



Figure 71. pH/ORP Module

The pH/ORP module in the SP-600 can be replaced when the original module reaches the end of its working life. Pyxis offers a 6-month warranty on the pH/ORP module. Pyxis recommends replacing the module at a frequency of every 9–12 months as a best practice. Order a replacement pH/ORP module (P/N: 50315) from Pyxis at order@pyxis-lab.com. If the module is turned on for 20 minutes a day, the module battery can last for about a year. The module indicator light will flash red if the module battery is low. Each replacement pH/ORP module will be shipped with a COC (Certificate of Calibration). The COC also includes an assigned Bluetooth MAC-Address for the new module. This MAC-Address will appear as an available device to pair the SP-600 main module to per the instructions below.

11.4.1 Replacement Procedure

Follow the instructions below to install the replacement module:

1. Power off the SP-600 by holding .
2. Remove any liquid from both the conductivity/chlorine cell and the old pH/ORP cell.
3. Detach the old pH/ORP module by pulling the module away from the main module.
4. Remove the battery from the old pH/ORP module to prevent it from re-pairing to the SP-600.
5. Dispose of the old module. If the removed battery still has charge, it can be saved for future use.
6. Attach the new pH/ORP module to the main module as shown in Figure 72.
7. To Bluetooth pair the main module with the new pH/ORP module, continue to the **Bluetooth Pairing** section below.

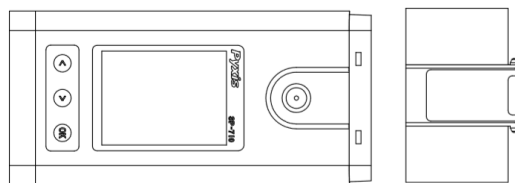

Figure 72.

11.4.2 Bluetooth Pairing

1. Power on the SP-600 by pressing **OK**.
2. Press **Cal/Sys** (**OK**) to launch the **DEVICE INFORMATION** screen.
3. Press **Pair** (**OK**) to launch the **COMMUNICATION** screen (Figure 73).
4. Press **Scan** (**<** or **>**) to begin scanning for Bluetooth devices.
5. Discoverable devices will begin to populate on the display with their name and MAC-Address (Figure 74).

**NOTE* To verify pairing to the correct pH/ORP module, the MAC-Address of the pH/ORP module can be found in its provided COC (Certificate of Calibration).*
6. If more than one device appears in the **Device list**, press **>** (**>**) to cycle through the devices.
7. If no devices or the incorrect device appear in the **Device list**, press **Scan** (**<**) to re-scan for discoverable devices.
8. Press **Pair** (**OK**) to begin pairing to the selected device.
9. If pairing is successful, the message "Pair Success!" will appear in the top-left corner of the display (Figure 75).
10. Bluetooth pairing is complete. Long press **Pair** (**OK**) to return to Conductivity mode.

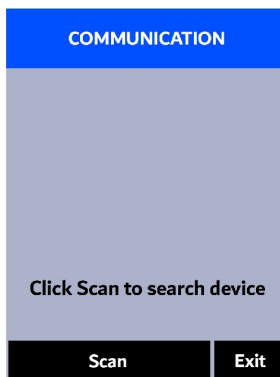

Figure 73.



Figure 74.

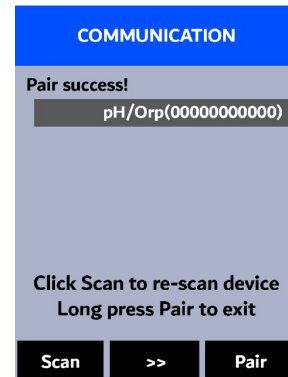

Figure 75.

12 Regulatory Approval

United States

The SP-600 sensor has been tested and found to comply with the limits for a Class B digital device, pursuant to part 15 of the FCC Rules. These limits are designed to provide reasonable protection against harmful interference in a residential installation. This equipment generates, uses and can radiate radio frequency energy, and if not installed and used in accordance with the instructions, may cause harmful interference to radio communications. However, there is no guarantee that interference will not occur in an installation. If this equipment does cause harmful interference to radio or television reception, which can be determined by turning the equipment off and on, the user is encouraged to try to correct the interference by one or more of the following measures:

- Reorient or relocate the receiving antenna.
- Increase the separation between the equipment and receiver.
- Connect the equipment into an outlet on a circuit different from that to which the receiver is connected.
- Consult the dealer or an experienced radio/TV technician for help.

Canada

This device complies with Industry Canada license exempt RSS standard(s). Operation is subject to the following two conditions: (1) this device may not cause interference, and (2) this device must accept any interference, including interference that may cause undesired operation of the device.

Le présent appareil est conforme aux CNR d'Industrie Canada applicables aux appareils radio exempts de licence. L'exploitation est autorisée aux deux conditions suivantes: (1) l'appareil ne doit pas produire de brouillage, et (2) l'utilisateur de l'appareil doit accepter tout brouillage radioélectrique subi, même si le brouillage est susceptible.

13 Contact Us

Pyxis Lab, Inc

21242 Spell Circle

Tomball, TX 77375 USA

www.pyxis-lab.com

Phone: +1 (866) 203-8397

Email: service@pyxis-lab.com