

Pyxis®

IK-765SS-SO3 Sulfite + pH Analyzer *for Process, Feedwater & Boiler*



Pyxis Lab® Inc.

1729 Majestic Dr. (Suite 5)
Lafayette, CO 80026
www.pyxis-lab.com

USER MANUAL

V1.2



Related Statements

The manufacturer shall not be liable for direct, indirect, special, incidental, or consequential damages resulting from any deficiency or omission in this manual. The manufacturer reserves the right to make changes to this manual and the products described in it at any time without notice or liability. Revised versions can be found on the manufacturer's website.

Safety Information





Please read this manual completely before unpacking, installing, and operating this equipment. In particular, pay attention to all dangers, warnings, and precautions, otherwise, it may cause serious personal injury to the operator or damage to the equipment.

Use of Danger Information

 Danger
Indicates a potentially or urgent dangerous situation that, if not avoided, will cause death or serious injury.
 Warning
Indicates a potentially or very dangerous situation that, if not avoided, may cause serious personal injury or death.
 Warning
Indicates a potentially dangerous situation that may cause a certain degree of personal injury.
Attention
Indicates conditions that if not avoided, will cause damage to the instrument. This is information that needs special emphasis.

Warning Label

Please read all labels and marks attached to the instrument. Failure to follow the instructions on these safety labels may result in personal injury or damage to the instrument.

	If this symbol appears in the instrument, it means refer to the operation and/or safety information in the instruction manual.
	If there is this mark on the instrument housing or insulator, it means there is a risk of electric shock or death from electric shock.
	Static electricity can damage the delicate internal electronic components, resulting in reduced performance or eventual failure of the instrument.
	Electrical equipment marked with this symbol cannot be disposed of through the European public waste system after August 12, 2005. In order to comply with European regional and national regulations (EU Directive 2002 / 98 / EC), European electrical equipment users must now return abandoned or expired equipment to the manufacturer for disposal without any cost.

Catalog

1. Specifications	- 1 -
2. IK-765SS-SO3 Panel Features	- 2 -
3. Dimension and Mounting	- 3 -
3.1. Dimension	- 3 -
3.2. Tube connection	- 3 -
3.3. Terminal Wiring	- 4 -
4. Touch Screen Operation	- 5 -
4.1. Main Screen	- 5 -
4.2. User Login	- 5 -
4.3. Real-Time Monitoring	- 6 -
4.4. Menu Bar	- 7 -
4.5. Configurable Parameters	- 7 -
4.5.1. Alarm Parameters Setting	- 7 -
4.5.2. Name Definition	- 8 -
4.5.3. Diagnostic Parameters	- 8 -
4.5.4. 4-20mA Output Parameters Setting	- 9 -
4.5.5. Communication Setting	- 9 -
4.6. Calibration	- 10 -
4.6.1. pH Calibration	- 10 -
4.6.2. SO3 Calibration	- 12 -
4.7. Alarm View	- 13 -
4.8. Historical Data	- 14 -
4.9. Historical Data Curves	- 15 -
4.10. User Management	- 17 -
5. Daily Maintenance	- 18 -
5.1. Correspondence Address	- 18 -
5.2. Operation and Maintenance	- 18 -
5.3. Instrument Alarms and Descriptions	- 19 -
6. Replacing pH and Oxidizer Electrode Head	- 20 -
7. Updating Time, Date and Firmware	- 21 -
7.1. Setting Time and Date	- 21 -
7.2. Firmware Update Procedure	- 23 -
8. Order Details	- 26 -

1. Specifications

Item	IK-765SS-SO3
P/N	42163
Sensor Body Material	304SS
Sensor Name	ST-765SS-SO3
Sulfite Range	0.00-100.00 ppm Sulfite (auto-range)
Sulfite Precision	± 1.0mg/L or 1% of the value w/pH compensation up to 9.0+
pH Range	0-14
pH Precision	± 0.01 pH
Sample Operating Temperature	4 °C – 40 °C (40 – 104 °F)
Sample Inlet Pressure	7.25 – 30 psi (0.05 – 0.2MPa)
Sensor Maximum Pressure	100 psi (6.9 Bar)
Sensor Response Time	T95≤60s – Oxidizer / T95≤5s - pH
Measurement Interval	Continuous
Installation	ST-007 (316L) Flow Cell w/PRV-Rotameter-Hall Effect Flow Meter Included
ST-007 Minimum Flow Rate	200 mL/minute
ST-007 Maximum Flow Rate	400 mL/minute
ST-007 Sample Inlet	1/4 - inch OD
ST-007 Sample Outlet	1/4 - inch OD
Panel Power Supply	96-260VAC / 50-60 Hz; 10 W
Panel Storage Temperature	-4 – 158 °F (-20 – 70 °C)
Panel Operating Temperature	32 – 122 °F (-0 – 50 °C)
UC-80 Display	4.3-inch LCD Color 480 x 272 Pixel Resolution / Resistive Touch
UC-80 Input	RS-485 Modbus – RTU
UC-80 Output	2 x 4-20 mA / RS-485 Modbus-RTU / Modbus-TCP
UC-80 Data Storage	Built-In 128MB of Ram for Storing up to 1-Million Data/Event Records
UC-80 USB	1 x USB host, for data downloading and screen upgrade
UC-80 Relative Humidity	20% - 90% (No Condensation)
UC-80 Altitude	<6,561 feet (<2,000 Meter)
Dimension (H x W x D)	Panel (IK-765SS-SO3) 440H x 350W x 153D mm
Approximate Weight	Panel (IK-765SS-SO3) ~ 15 kg
Wet Material	316L Stainless Steel / Polycarbonate
Rating	IP-65 Panel-Display / IP-67 Sensor
Selectivity	Non-Selective / cross sensitive to other oxidizing species
Compliance	EPA 334.0 / ISO 7393
Regulation	CE Marked / RoHS
Typical Electrode Service Life	2 years
Electrode Warranty	6 Months
Sensor Body Warranty	13 Months

NOTE - Pyxis Lab is consistently updating technologies, as such, specifications may change without notice. Contact info@pyxis-lab.com for details or www.pyxis-lab.com.

2. IK-765SS-SO3 Panel Features

The IK-765SS-SO3 is a dual-parameter inline water analyzer specifically designed as a ‘Turn-Key’ monitoring solution for clean water applications to monitor Sulfite in water commonly used in water and process applications for scavenging of Chlorine and Oxygen. The IK-765SS-SO3 offers highly accurate, real-time measurement, display and data-logging of Sulfite (SO₃), pH and Temperature utilizing proprietary Pyxis Lab smart sensor technology, coupled with a Pyxis UC-80 touch screen display and data logging terminal. The IK-765 series is offered in a convenient and easy to integrate panel mounted format for rapid installation and simple maintenance.



Features

- Pyxis Lab’s advanced research and development sensor technologies to achieve highly accurate and stable measurement of Sulfite, pH, and Temperature.
- Pyxis ST-765SS-SO3 is a three-parameter composite sensor used for the measurement Sulfite, pH, and temperature in compliance with USEPA 334.0 and ISO-7393 guidelines. The sensors advanced PCB offers built-in temperature and pH parameter compensation (up to pH 9.0+) algorithms eliminating the need for a supplemental pH sensor and controller. Unique Bare-Gold electrode technology for Sulfite measurement eliminates membranes and electrode solution replenishment commonly associated with conventional sensors. The ST-765SS Series has a uniquely designed flat bubble pH electrode design for reduced fouling potential. Reduce your maintenance and cost versus conventional electrochemical sensors by utilizing Pyxis replaceable Electrode Head (EH-765) for this sensor allowing for years of reliable service. The ST-765SS Series may be calibrated in-situ after cleaning via DPD or similar Sulfite wet chemistry test measurement of active sample.
- Pyxis ST-007 Single-Sensor inline stainless steel flow cell provides an Sulfite demand-free environment for the safe installation and accurate operation of the ST-765SS-SO3 sensor. The inlet and outlet to the ST-007 are 316L stainless steel with SwageLok fittings in ¼-inch OD. The IK-765SS-SO3 panel is also equipped with inlet PRV, Rotameter and digital Hall Effect inlet flow meter for precise control and recording of the recommended flow range of 200-400 mL/minute. The outlet flow should be diverted to drain or the inlet of the pretreatment system for those desiring NSF compliance.
- Simple sensor removal and replacement. The ST-765SS Series sensors are connected to the display/data logger via RS-485 Modbus (RTU) allowing for integrated sensor calibration interface and diagnostics within the display screen.
- Convenient and simple to install Back-Panel (IK-765) for rapid and easy installation. Truly a plumb and power to go platform with intense factory setup, testing and sensor calibration prior to shipment.
- UC-80 touch screen color display/data logger prewired to the Pyxis sensor via RS-485 with calibration interface. Display/data logger offers 2x 4-20mA, RS-485 and TCP Modbus output with remote diagnosis and parameter adjustment. Pyxis PowerCloud™ 4G Gateway available as an optional accessory.

3. Dimension and Mounting

3.1. Dimension

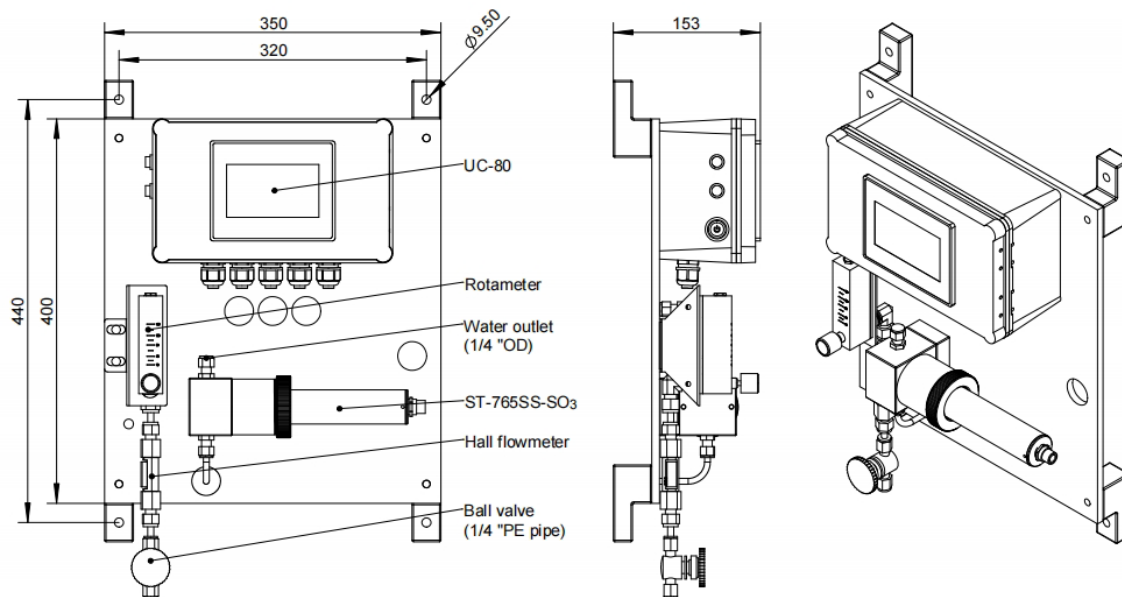

Figure. 1 - IK-765SS-SO3 controller size and installation size

Power Supply: 100~240V AC 50/60Hz

Water Supply: Inlet water pressure should be from 7.25 – 30 psi (0.05-0.2MPa) with an inlet feedwater line diameter of ¼-inch OD.

Drainage: Outlet pipe diameter is ¼-inch OD, should both be connected to a discharge drain via gravity flow.

Wall Mount Space: The IK-765SS-SO3 analyzer panel size is roughly 440H x 350W x153D (mm) in dimension. Please accommodate sufficient space for mounting.

Wall Mount Weight: Approximately 15kg. Please use appropriate mounting hardware.

3.2. Tube Connection

Inlet Water: Connect the ¼-inch OD inlet water tubing to the quick adapter provided.

Outlet Line: Connect ¼-inch OD stainless steel inlet tubing to stainless steel fittings.

3.3. Terminal Wiring

The IK-765SS-SO3 analyzer has universal AC power supply equipment allowing users simply to plug the power supply into a 100~240V AC 50/60Hz power outlet for normal operation.

Warning

⚠ The process of electrical connection to contact the 220V single-phase power supply, should be operated by personnel with an electrician's license. Failure to operate according to the electrical code of practice may result in electric shock injury or even death.

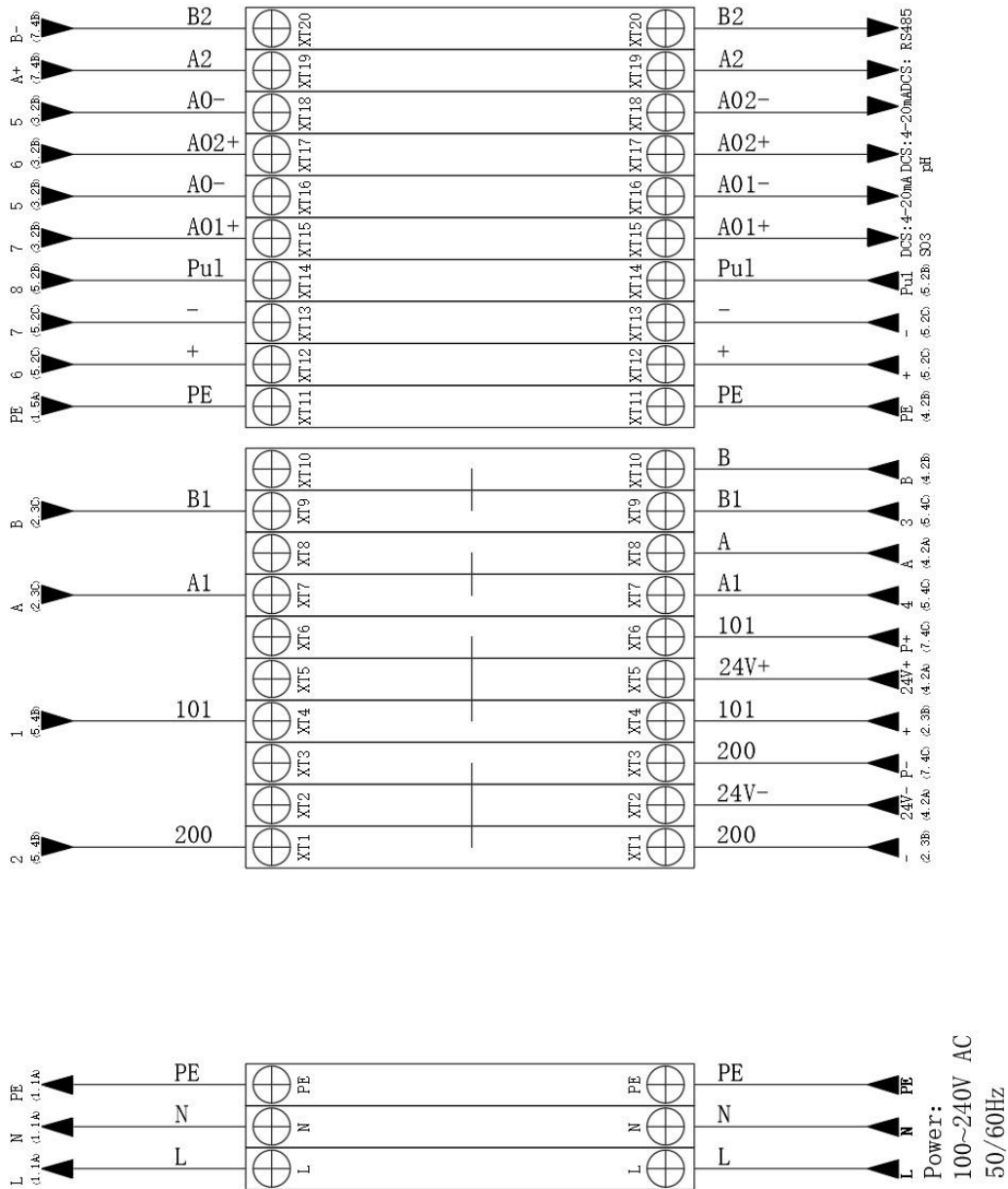

Figure. 2 - Terminal Wiring Diagram

4. Touch Screen Operation

4.1. Main Screen

After the system is powered on an initial screen allows the user to log into the system.



Figure. 3 - Main Screen

4.2. User Login

After powering on the system, log in with the username and password to be able to change system settings. Click the "User Login" button, select the user "User", enter the password: "888888" in the user password field. A new user can be added via "User Management" in interface of the menu.

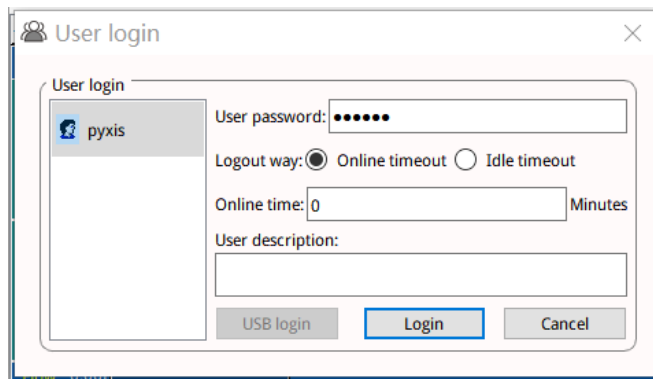

Figure. 4 - User Login Screen

If you do not need a password, or want to change the user, you can enter the system and manage in the "User Management" screen of the menu.

4.3. Real-Time Monitoring

Click the "Enter System" button on the main interface to enter the real-time monitoring screen of the system. The data detected by the Pyxis sensors will be displayed in real-time. See a functional overview of each section of this screen highlighted below. (Numbers 1-4)



Figure. 5 - Real-time monitoring screen

Section Number	Functional Overview
1	The blue area will scroll any alarm information in real time until the alarm is cleared.
2	Real-time display of current sensor measurement value.
3	Real-time display of the current sensor's 4-20mA signal value.
4	Historical data is recorded as a live curve, with the horizontal coordinate being the time and the vertical coordinate being the measured value.

Table 1 - Main interface functional overview

Press and hold the curve area for 2 seconds and then let go, the Y-axis curve range setting dialog box will appear. Users may change the display value range of Y-axis for each measurement index curve. Click the outer area of the screen to save and exit the setting screen after modifications are made.

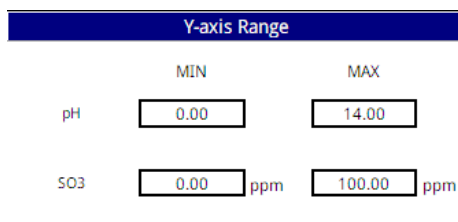

Figure. 6 - Curve Range Setting

4.4. Menu Bar

Click the button in the upper left corner of the screen to enter the system's menu interface, where the user can select to enter the desired operation interface.

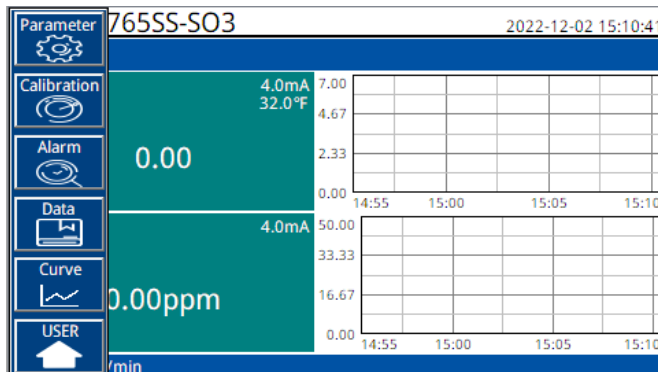

Figure. 7 - Menu Bar

4.5. Configurable Parameters

Click the "Parameter" button in the menu bar. Here you can select to enter "Alarm Parameters" and "4-20mA Output" setting interface etc.

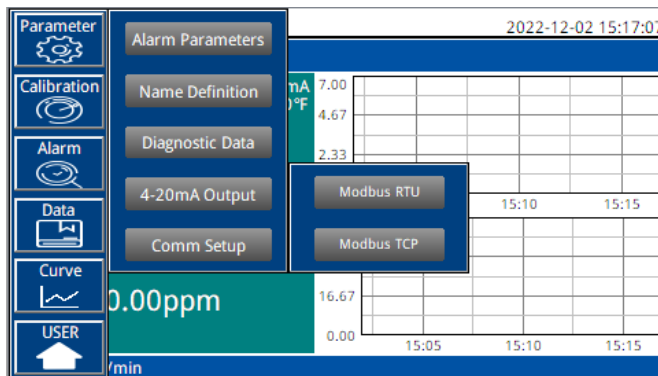

Figure. 8 - Parameter Settings

4.5.1. Alarm Parameters Setting

Users can set the upper and lower alarm limits. Click "Alarm Parameters" to enter the alarm parameter settings. When the measured sensor value is lower than the set lower limit (the XX lower limit alarm) or when the measured value is higher than the set upper limit (the XX upper limit alarm), the corresponding sensor alarm will be displayed on the real-time monitoring screen. The user can also choose to turn the alarm display on or off at the top left of the corresponding parameter list.

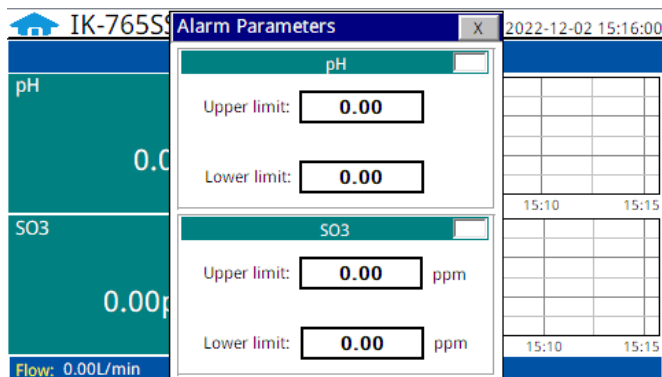

Figure. 9 - Alarm Parameter Setting

4.5.2. Name Definition

Click the orange dialog box to customize the sensor name.

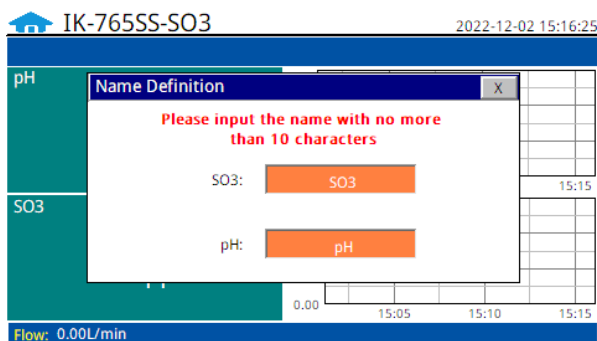

Figure. 10 - Name Definition

4.5.3. Diagnostic Parameters

Click “Diagnosis Parameters” to the diagnosis page. In the diagnosis page, the raw data measured by the probe is displayed. To help troubleshooting possible issues with the probe, please save an image of this data when the probe is placed in a clean water, in a standard, and in the sample that the probe is intended for.

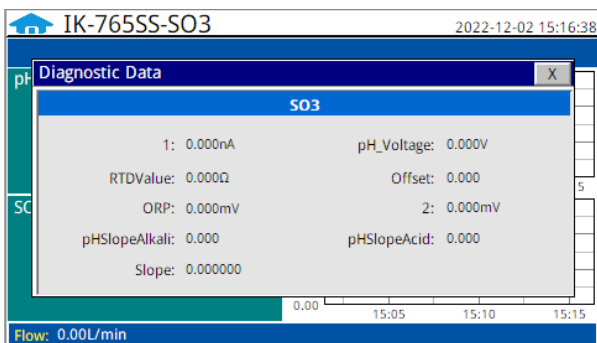

Figure. 11 - Diagnostic Parameters

4.5.4. 4-20mA Output Parameters Setting

Click "4-20mA Output " to enter the 4-20mA output parameter setting interface. The 4mA and 20mA output values should corresponds to the lower and upper limits of the sensor range. ***NOTE*** The closer the value is set to the measurement value the more accurate the data. It is recommended to set according to the range of the sensor.

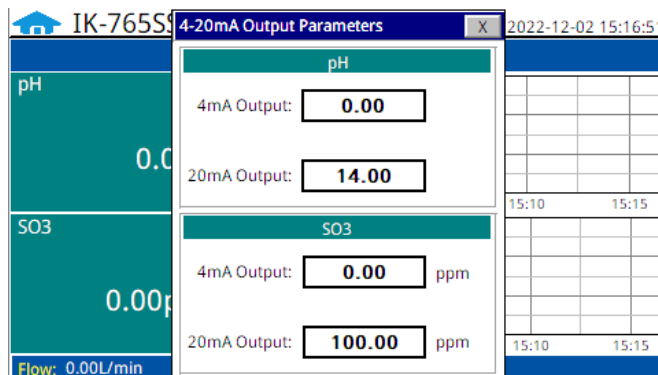

Figure. 12 - 4-20mA Output Setting

4.5.5. Communication Setting

Communication parameters generally do not need to be changed. If the communication station number and other parameters need to be changed on site, they can be changed on this interface.

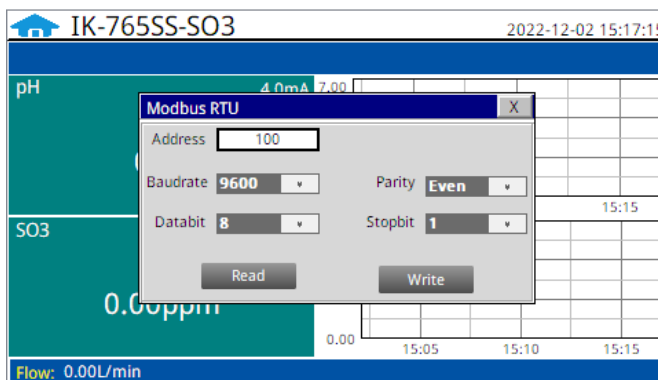

Figure. 13 - Modbus RTU

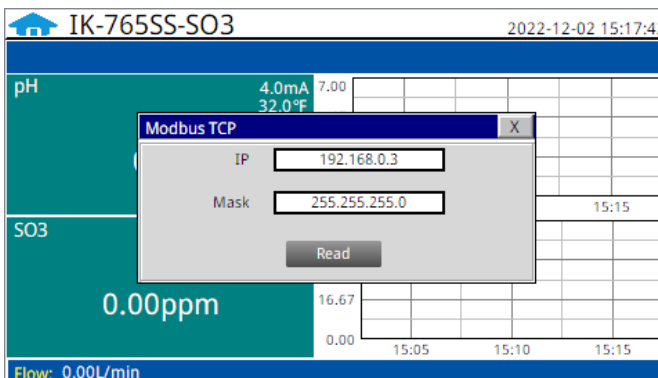

Figure. 14 - Modbus TCP

4.6. Calibration

Click on the "Calibration" button in the menu bar and select the sensor to be calibrated.

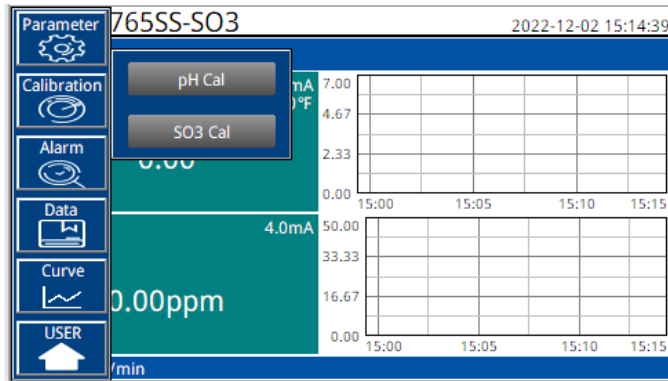

Figure. 15 - Sensor Calibration

4.6.1. pH Calibration

The pH function is thoroughly calibrated at the Pyxis Lab factory. After checking with a pH standard buffer solution, if the sensor value has shifted, then the user may choose from single-point, two-point or three-point calibration to re-calibrate the pH portion of the ST-765SS-SO3 sensor as desired.

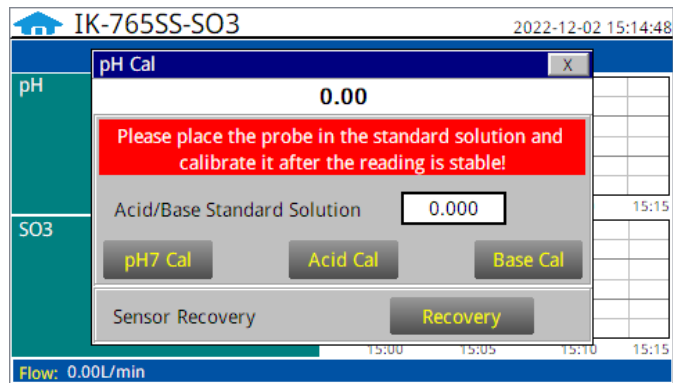

Figure. 16 - pH Calibration

Single Point pH Calibration

Remove the ST-765SS-SO3 sensor and rinse 3x with DI water. Submerge the sensor into a beaker with pH=7 buffer solution. Click "pH7 calibration". A dialog box will pop up to confirm whether to perform this operation, click "OK" if the calibration operation is confirmed, if the calibration is successful the dialog box will show "calibration success".

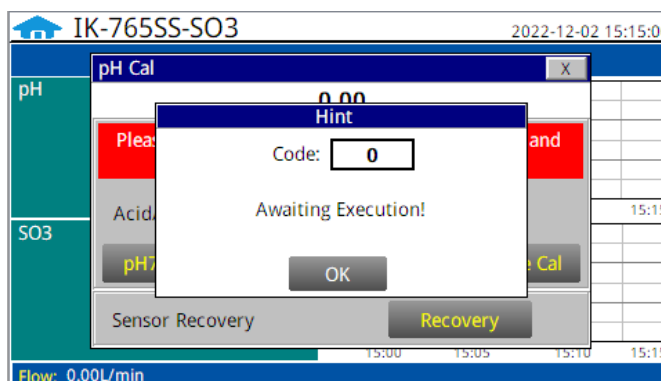

Figure. 17 - pH Calibration Success Prompt

Two Point pH Calibration

Remove the ST-765SS-SO3 sensor and rinse 3x with DI water. Submerge the sensor into a beaker with pH=7 buffer solution. Click "pH7 calibration". A dialog box will pop up to confirm whether to perform this operation, click "OK" if the calibration operation is confirmed, if the calibration is successful the dialog box will show "calibration success".

After pH7 is successfully calibrated, you can choose acid calibration or alkali calibration for the second calibration point. If you choose acid calibration, clean beaker 3x with deionized water. Fill the beaker with pH=4 buffer solution. Enter the value 4 in the calibration value dialog box, and click "Acid Calibration", then a dialog box will pop up to confirm whether to perform this operation. Click "OK" if the calibration operation is confirmed and the dialog box will show "Calibration Successful" if the calibration is successful. Similarly, a pH=10 buffer solution can be selected for the second point calibration if desired.

Three Point pH Calibration

Remove the ST-765SS-SO3 sensor and rinse 3x with DI water. Submerge the sensor into a beaker with pH=7 buffer solution. Click "pH7 calibration". A dialog box will pop up to confirm whether to perform this operation, click "OK" if the calibration operation is confirmed, if the calibration is successful the dialog box will show "calibration success".

After pH7 is successfully calibrated, you can choose acid calibration or alkali calibration for the second calibration point. If you choose acid calibration, clean the beaker 3x with deionized water. Fill the beaker with pH=4 buffer solution. Enter the value 4 in the calibration value dialog box, and click "Acid Calibration", then a dialog box will pop up to confirm whether to perform this operation. Click "OK" if the calibration operation is confirmed and the dialog box will show "Calibration Successful" if the calibration is successful.

After successful acid calibration, select pH=10 for alkali calibration. Clean the beaker 3x with deionized water. Fill the beaker with pH=10 buffer solution. Enter the value 10 in the calibration value dialog box, and click "Alkali Calibration", then a dialog box will pop up to confirm whether to perform this operation. Click "OK" if the calibration operation is confirmed and the dialog box will show "Calibration Successful" if the calibration is successful. The three-point calibration is completed.

4.6.2. SO3 Calibration

The measurement module of the ST-765SS-SO3 sensor is thoroughly calibrated at the Pyxis Lab factory. To calibrate, the user can perform a single point calibration according to the requirements of the application.

Calibration of the ST-765SS-SO3 sensor for Sulfite should be done with the sensor inline exposed to active flowing sample water. Use titration, colorimeter or fluorometer methods (i.e. Pyxis SP-800 / SP-910, Hach DR-1300 or similar) to test the active (flowing) water sample in the flow tee assembly of the IK-765SS-SO3 panel. Once you have tested and confirmed the Sulfite concentration value in the active (flowing) flow tee assembly, enter the recorded test result value in Calibration Screen and click "High Cal". A dialog box will pop up to confirm whether to perform this operation. If the calibration operation is confirmed, click "OK", and if the calibration is successful, the dialog box will show "Calibration Success".

NOTE Click the restore button in the calibration interface of each sensor to restore the data of pH/residual SO3 sensor. If a user error is made during calibration and other operations, you may restore the factory settings of the sensor through the restore function.

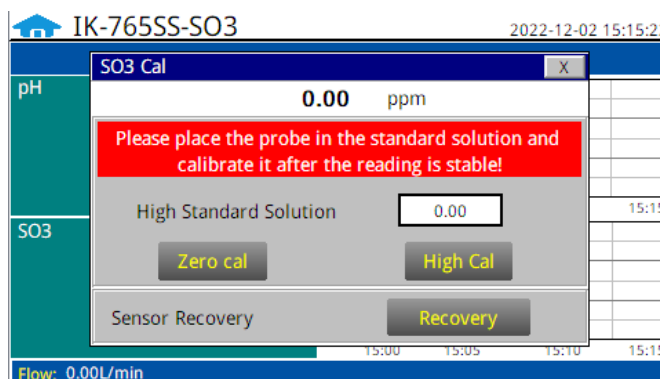

Figure. 18 - SO3 Calibration

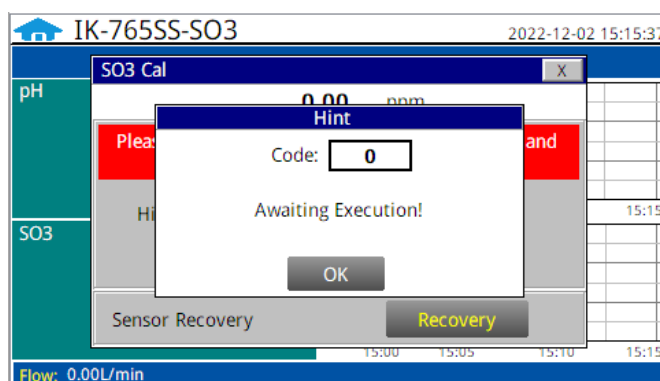

Figure. 19 - Awaiting execution Screen of SO3 Calibration

4.7. Alarm View

Click the "Alarm View" button on the main screen to enter the alarm view screen.

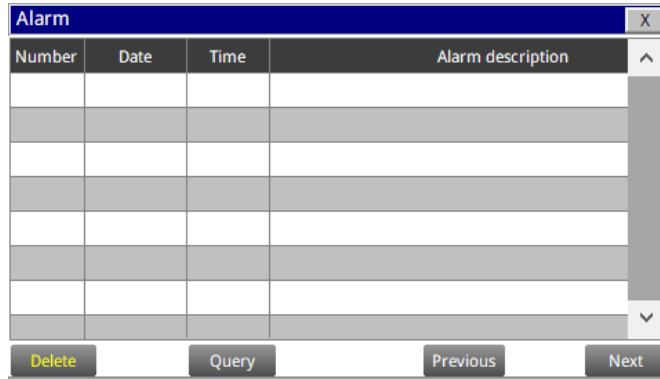

Figure. 20 - Alarm View

In this screen users can browse all logged alarms. Drag the right scroll bar up and down to view the history of alarms. Click "Previous" and "Next" to advance to the next page. Click "Query" then enter the alarm number in the pop-up box to query that alarm.

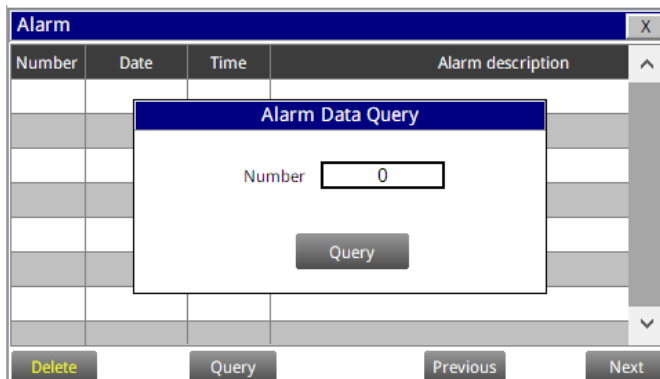

Figure. 21 - Alarm Data Query Screen

The Delete button in the lower left corner will delete all alarm records. After clicking delete, you must exit the screen and reenter before the historical data within the data report will be cleared.

4.8. Historical Data

Click the "Historical Data" button in the menu bar to enter the data report interface.

Number	Time	SO3	pH	Temp
1	2022-11-29 15:11:26	0.00	0.00	32.0
2	2022-11-29 15:10:26	0.00	0.00	32.0
3	2022-11-29 15:09:26	0.00	0.00	32.0

Figure. 22 - Historical Data Screen

In the data report, the user can view the stored data of all parameters. The system records sensor readings every 4 seconds by default but this can be edited by the user if desired. Drag the scroll bar on the right to slide up or down or click "Previous" and "Next" to view historical data records. The data record can save up to 100,000 data entries. New data will overwrite the previously saved data after recording 100,000 data entries. The user can click the "Periodicity" button to change the data recording time interval.

Figure. 23 - Data Storage Cycle Time Setting

Click "Delete" in the lower left corner. After entering the retention time, click the "Delete" button to clear all historical data within the retention time range.

Figure. 24 - History Data Deletion Screen

Click the “Query” button in the lower right corner, enter the start time and end time and then click the “Query” button. Note that the start time and end time must be filled in exactly and completely according to the system time format.

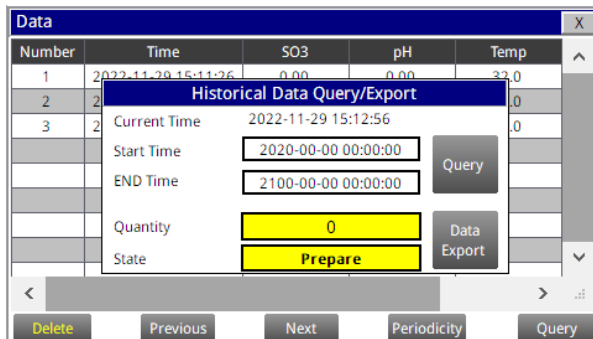

Figure. 25 - Historical Data Query and Export Screen

Insert a USB disk behind the display screen and enter the time range of the data to be exported in the query area. Click on the “Data Export” to download the data to the USB disk. The data quantity will be shown as a positive number if data export is successful. If the data export was not successful, please check whether the time format is correct.

4.9. Historical Data Curves

Click the "Historical Curve" button in the menu bar to enter the trend curve interface. You can click the buttons below the X-axis to browse and view the values in a different time range. Click on Y-axis Range to change the minimum and maximum Y-axis values for a proper range.

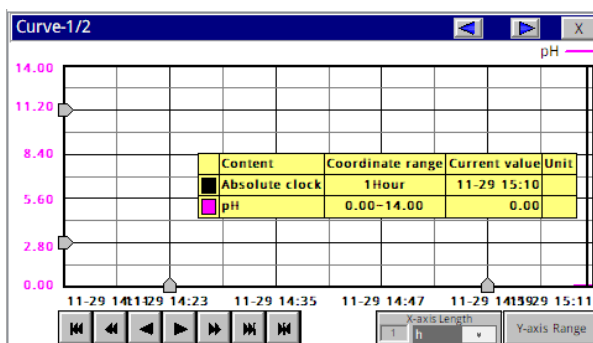

Figure. 26 - History Curve Screen

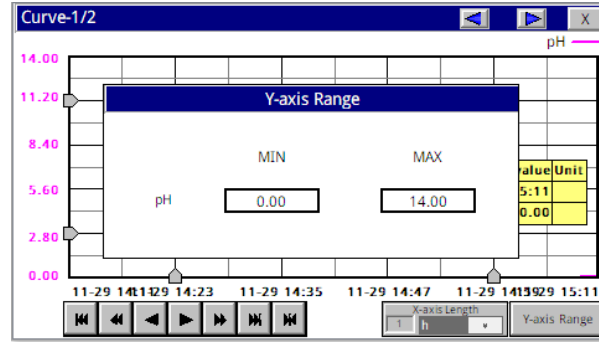

Figure. 27 - Y-axis Range Setting

- ⏪ The curve will scroll back (to the left of the X-axis) one page
- ⏩ The curve will scroll back (to the left of the X-axis) half the page of the curve
- ⏴ The curve will scroll backward (to the left of the X-axis) to a position where the main line is drawn
- ⏵ The curve will scroll forward (to the right of the X-axis) to a position where the main line is drawn
- ⏴⏴ The curve will scroll forward (to the right of the X-axis) half the page of the curve
- ⏵⏵ The curve will scroll forward (to the right of the X-axis) one page
- ⏴⏵ A dialog box will pop up to reset the starting time of the curve

Figure. 28 - Button Function Review

Figure. 29 - Time Setting Screen

4.10. User Management

Click the "User" button on the menu bar and then you can select "Login", "Logout" and "Manage" operations.



Figure. 30 – User Management

Logout enables the user to log out of the logged-in state and only view the real-time readings but cannot perform operations such as parameter settings. Click “Manage” to enter the user management interface, where you can add users, change passwords and other operations. Users can set their own username and password and select the user group they belong to. Only users in the administrator group can set parameters such as calibration.

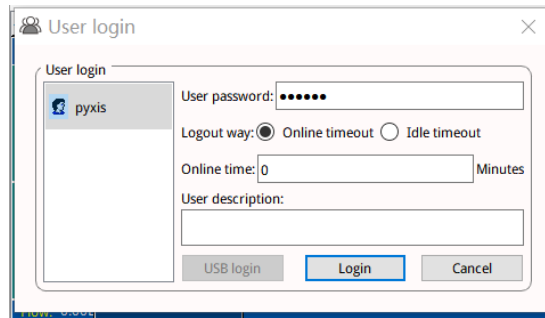

Figure. 31 - User Management Screen

Modify Password: Select the user you want to change, then click Modify User button, enter the user's own password in the User Password column and Confirm Password column, and click Confirm to modify successfully. ***NOTE*** If you do not want to set the password, you can delete the password and save it.

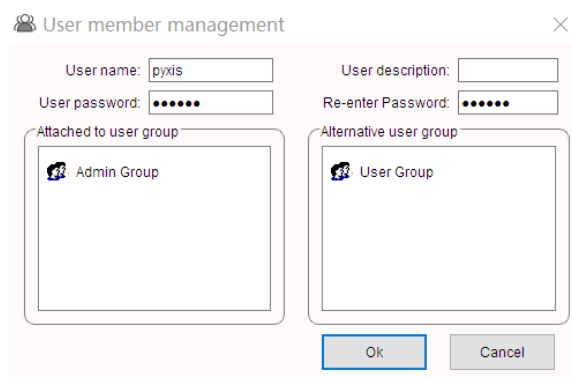

Figure. 32 Modifying the User Screen

5. Daily Maintenance

5.1. Correspondence Address

Table. 1 Correspondence Address

Number	Definition	Address	Format	Mode	Unit	Note
1	SO3	1	float	read only	ppm	Data format ABCD
2	pH	3	float	read only		Data format ABCD
3	Temp	5	float	read only	°F	Data format ABCD
4	Flow	7	float	read only	L/min	Data format ABCD
5	SO3 lower limit alarm	9	uint	read only		0: normal 1: Alarm
6	SO3 upper limit alarm	10	uint	read only		0: normal 1: Alarm
7	pH lower limit alarm	11	uint	read only		0: normal 1: Alarm
8	pH upper limit alarm	12	uint	read only		0: normal 1: Alarm
9	SO3 sensor communication is abnormal	13	uint	read only		0: normal 1: Alarm
10	The communication of the analog module is abnormal	14	uint	read only		0: normal 1: Alarm
11	The communication of the traffic collection module is abnormal.	15	uint	read only		0: normal 1: Alarm
Communication Protocol: Standard Modbus-RTU						
Communication Parameters: Baud Rate - 9600, Data Bit - 8, Stop Bit - 1, Parity Bit - Even						
Station Number: 100						
Communication protocol: standard Modbus-TCP						
Communication parameters: IP: 192.168.0.3 (can be set); port: 502						
Station number: 1						

5.2. Operation and Maintenance

After the analyzer is installed by a qualified technician, it can begin to monitor water quality. The IK-765SS-SO3 is designed to be simple to operate, but still requires some regular maintenance. Actual system maintenance may vary depending on the installation conditions and usage. Please refer to the table below as a general recommended maintenance schedule guideline. Little operator intervention is required during normal operation.

Table. 2 - Maintenance Intervals

Required Services	Recommended Frequency
pH Calibration	Every 6 Months
SO3 Calibration	Every 6 Months or As needed

5.3. Instrument Alarms and Descriptions

Please refer to the instrument alarms and descriptions table when troubleshooting the IK-765SS-SO3 issues an alarm or indicates abnormal measurement data.

Table. 3 - Common Alarms

Alarms	Description	Symptoms	Solutions/Recommendations
PLC Communication Abnormalities	PLC without Communication		Check if the wiring inside the PLC and control box is loose
pH / SO3 Sensor Communication Abnormalities	pH / SO3 Sensor without Communication	No pH and SO3 Measurements	Check the connection between the sensor and the circuit board. If the problem persists, contact Pyxis.
pH Upper Limit Alarm	pH above the Alarm Setting	Information Only	Compare with manual measurement readings. Check and clean line valves. Check that water flow is normal. Check that the sensor is clean.
pH Lower Limit Alarm	pH below the Alarm Setting	Information Only	
SO3 Upper Limit Alarm	SO3 above the Alarm Setting	Information Only	
SO3 Lower Limit Alarm	SO3 below the Alarm Setting	Information Only	
pH/SO3 Calibration Failure Code 2		Calibration Failure	Check whether the water flow is normal, whether the sensor is clean, whether the standard liquid is contaminated
pH/SO3 Calibration Failure Code 3	Standard Solution Value out of Range	Calibration Failure	
pH/SO3 Calibration Failure Code 5	Wrong Data Type for the Liquid Value	Calibration Failure	

6. Replacing the ST-765 Series (pH and Sulfite) Electrode Head

The pH/Sulfite electrode head of ST-765SS Series can be replaced when the original electrode head reaches its working life. Order a replacement electrode head EH-765 (P/N 53061) from Pyxis and follow instructions as below.

1. Turn off the sensor if it is powered on.
2. Make sure there is no water on the sensor.
3. Hold the ST-765SS main body with one hand and use the other hand to twist the stainless-steel locking ring counter-clockwise until the front end of the black electrode is completely unscrewed, as shown in *Figure 33-2*.
4. Pull out the electrode head as shown in *Figure 33-3*.
5. Loosen the electrode plug connector, and remove the electrode head, as show in *Figure 33-4*.
6. To assemble the new electrode head, connect the plug, then insert the new electrode head into the main sensor housing and ensure that the two protrusions on the electrode head are aligned with the notches in the sensor main housing.
7. Then twist the stainless-steel lock ring of ST-765SS in a clockwise direction until the threads of the electrode head completely enter the ST-765SS housing as shown in *Figure 33-1*.

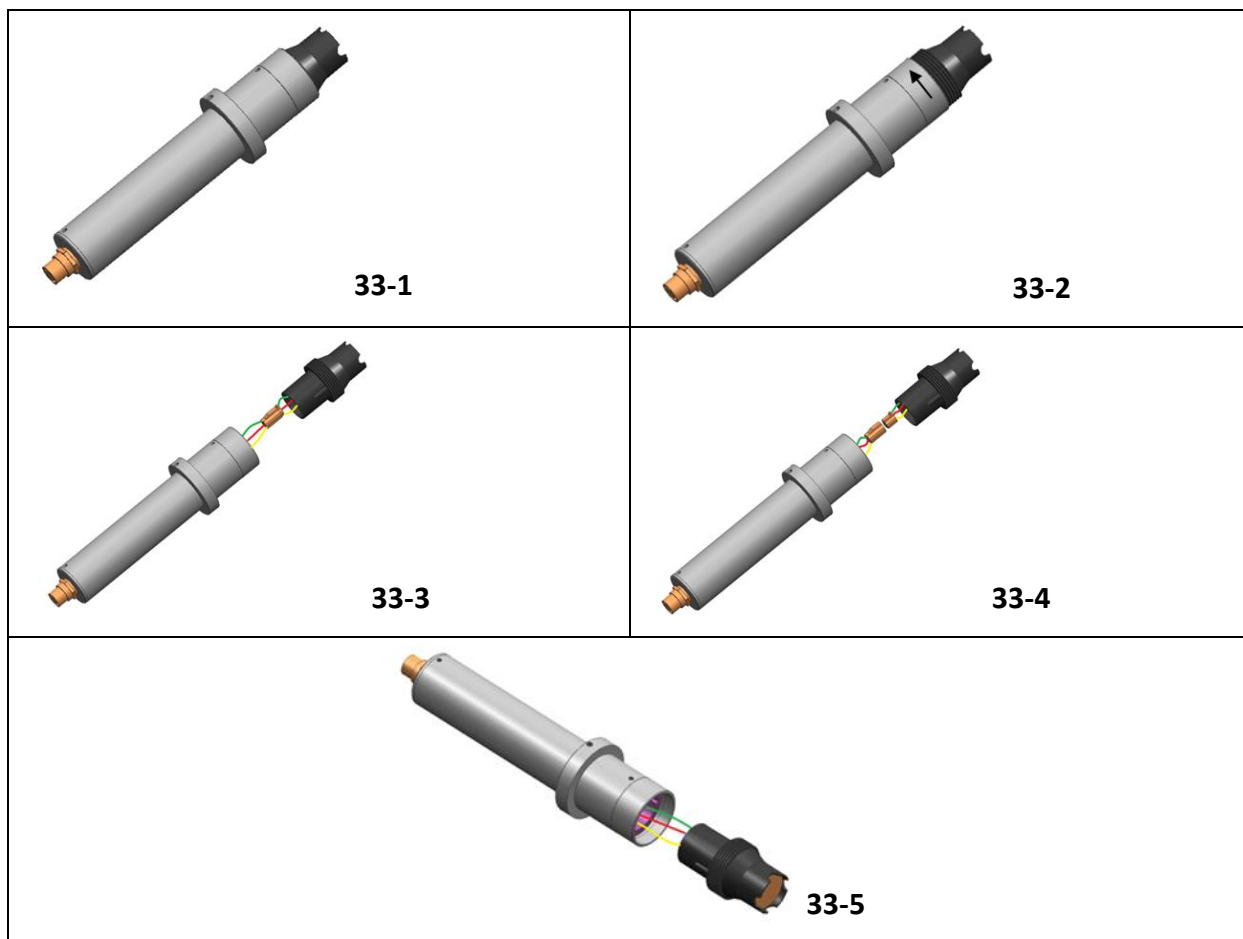

Figure 33 - Replacing EH-765 pH and Sulfite Electrode Head

7.0 UC-80 & UC-100 Series

Setting the Date, Time and Firmware Update Procedure

7.1. Setting the Date and Time

- 1) When the device is powered on again, when the following screen appears on the screen, tap the screen immediately

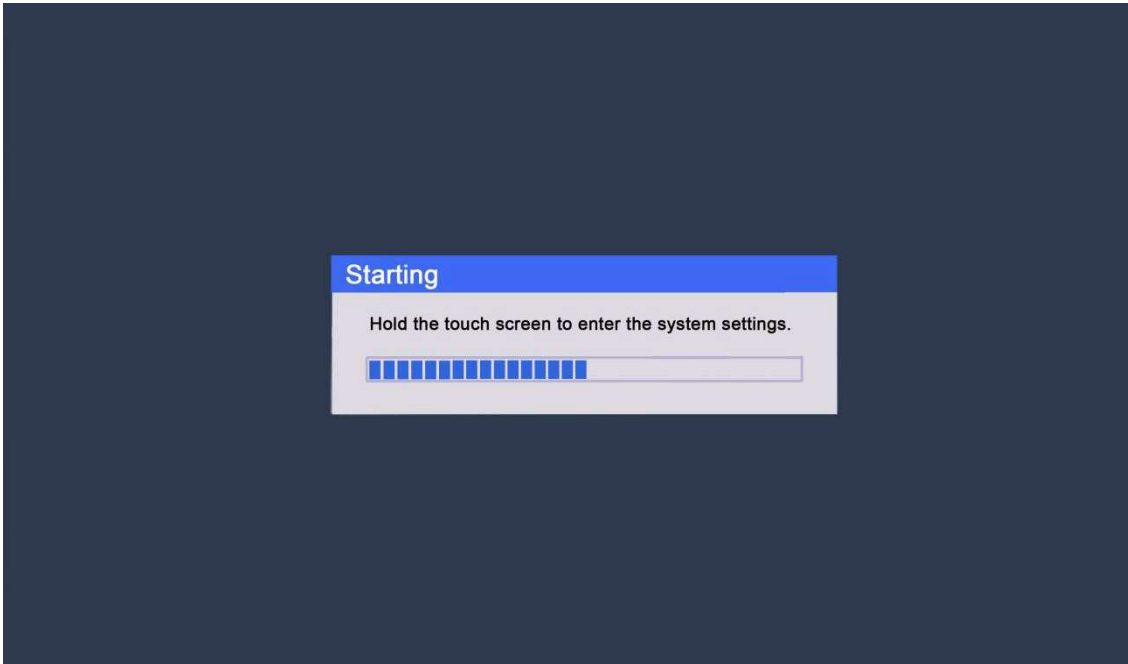

- 2) Enter the system interface, as shown in the figure below, click the button "System setting"

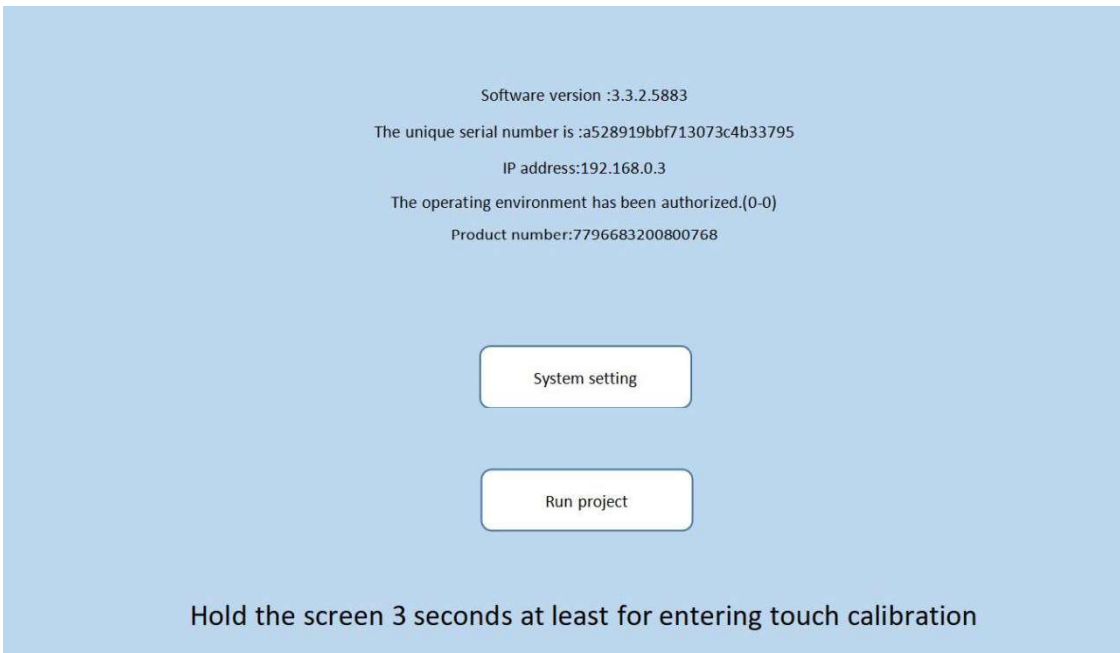

- 3) Enter the setting interface, select the time parameters, as shown in the figure below, and modify the time. After the modification is completed, click the "OK" button to confirm. After closing the setting interface, click "Run project" to enter the program running interface.

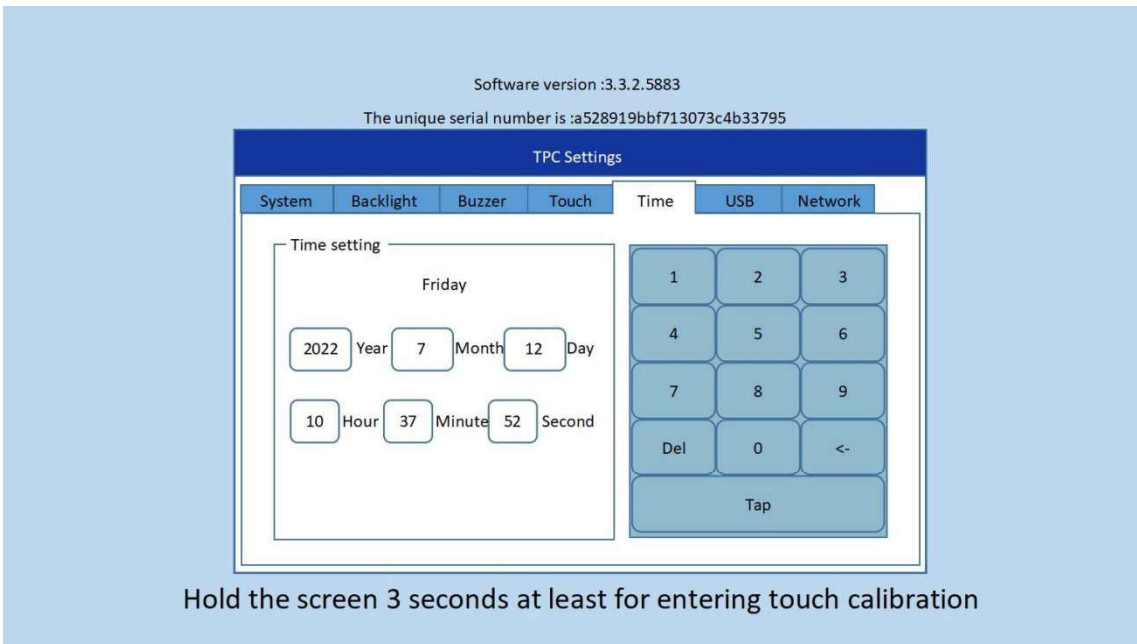

7.2. Firmware Update Procedure

- 1) Decompress the program update package, copy the "**tpcbbackup**" file and save it to a USB flash drive in "FAT32" format. ***NOTE*** You need to copy the entire folder to the root directory of the USB flash drive.
- 2) Insert the USB flash drive into the USB1 port on the rear of the touch screen.
- 3) After inserting the USB flash drive, the touch screen will pop up. Click "**YES**" and wait for the screen to jump, as shown below.

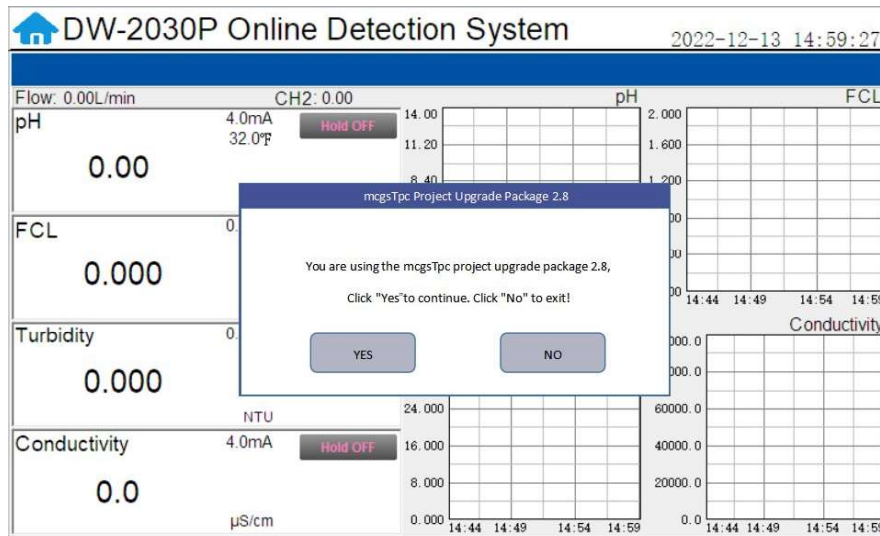

- 4) In the new pop-up box, click "**Download Project**", as shown below.

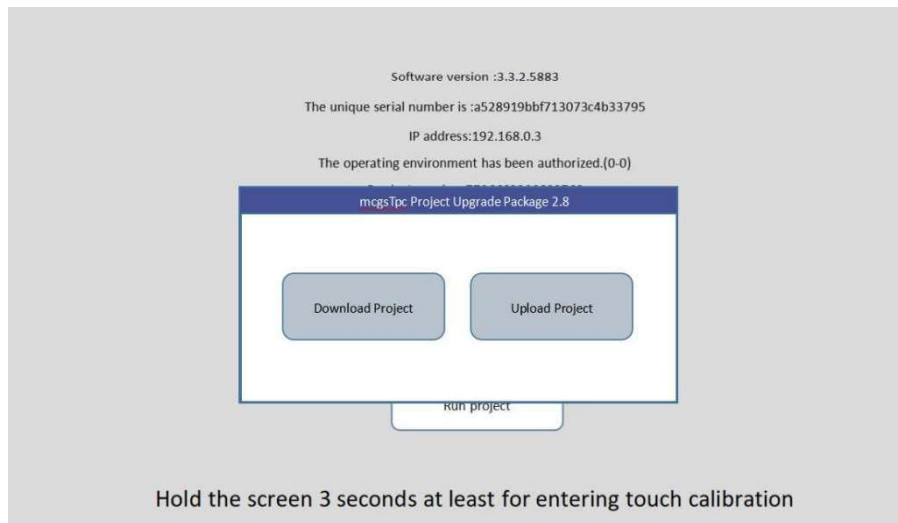

- 5) In the new pop-up box, select the program name on the left and click "**Download**". The touch screen will start to download the program. See figure below

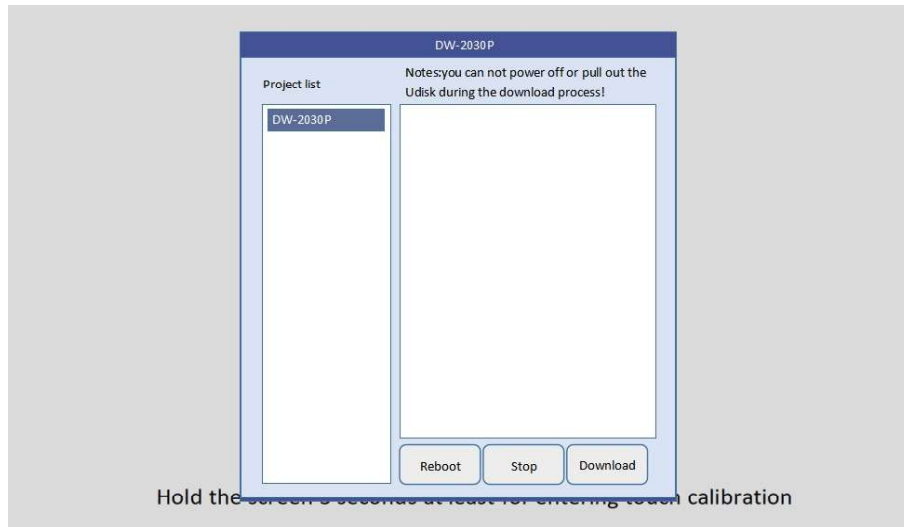

- 6) When the rewind is over, the touch screen will restart, and the screen will turn black during the restart. At this time, you can pull out the USB disk, as shown in Figure 4

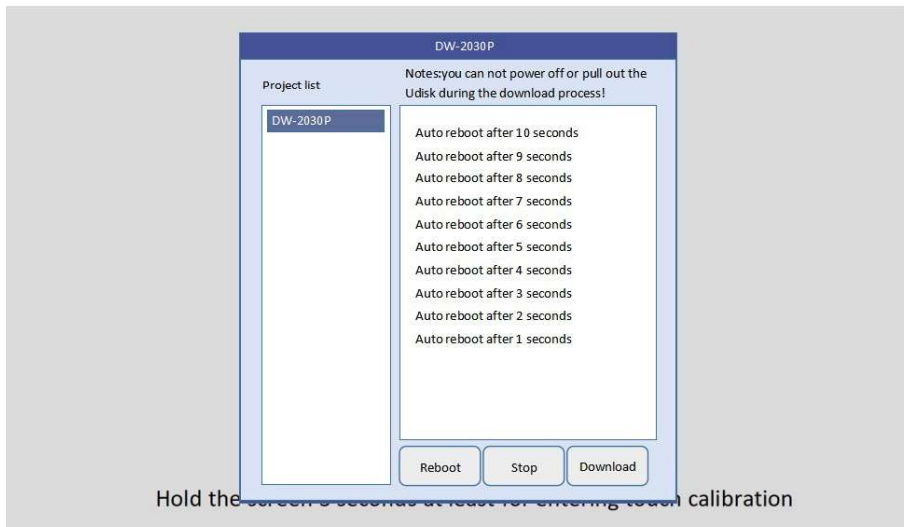

7) If the update screen appears again after restart, please click "NO" and pull out the USB disk, as shown in Figure 5

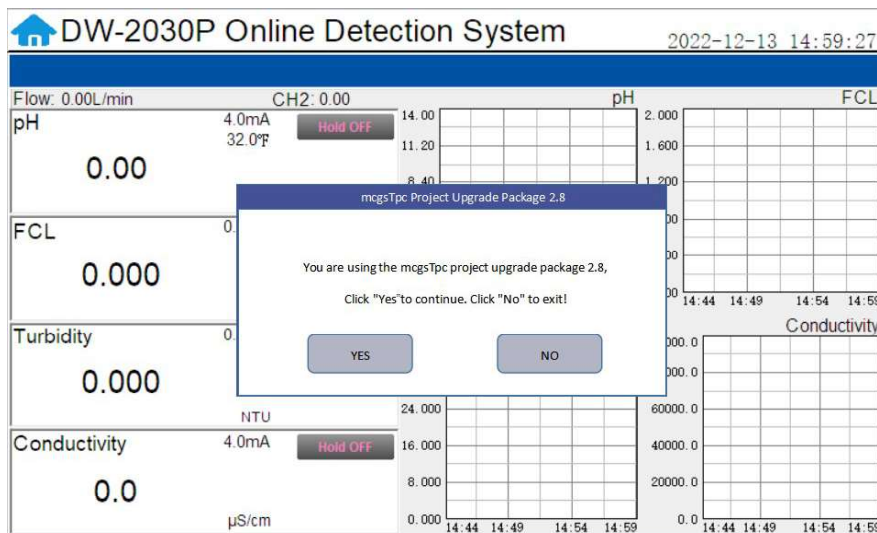

7. Order Details

Order Information

IK-765SS-SO3 (*Sulfite + pH + Temperature Analyzer*)

P/N

42163

Optional / Replacement Accessories Information

ST-765SS-SO3 (*Sulfite + pH + Temperature Sensor w/Internal Compensation*)

P/N

53624

EH-765 (*Replacement Electrode Head for ST-765SS-Series Sensors*)

53061

ST-007 (*Replacement ST-007 Stainless Steel Flow Cell*)

50700-A51

Rotameter Assembly Kit (*Replacement 0- 1.8LPM*)

22876

Stainless Steel Hall Effect Digital Flow Meter (*1/4-inch OD*)

22501

UC-80 Display + Data Logging Terminal (*Replacement*)

14003

Pyxis pH Combo Calibration Pack (*pH 4-7-10 Calibration Solution 3-Pack - 500mL ea.*)

57007

SP-800 (*Multi-Parameter Colorimeter*)

50610

Contact Pyxis Lab

info@pyxis-lab.com for general inquiries

service@pyxis-lab.com for technical service and support

order@pyxis-lab.com for order and pricing inquiries

1-866-203-8397 Phone USA for all needs

Office Hours 7AM – 5PM Mountain Time USA