

Pyxis®

IK-765SS-03 Ozone + pH Analyzer *for Bottled & Beverage Water*



Pyxis Lab® Inc.

1729 Majestic Dr. (Suite 5)

Lafayette, CO 80026

www.pyxis-lab.com

USER MANUAL

Related Statements

The manufacturer shall not be liable for direct, indirect, special, incidental, or consequential damages resulting from any deficiency or omission in this manual. The manufacturer reserves the right to make changes to this manual and the products described in it at any time without notice or liability. Revised versions can be found on the manufacturer's website.

Safety Information

Please read this manual completely before unpacking, installing, and operating this equipment. In particular, pay attention to all dangers, warnings, and precautions, otherwise, it may cause serious personal injury to the operator or damage to the equipment.

Use of Danger Information

 Danger
Indicates a potentially or urgent dangerous situation that, if not avoided, will cause death or serious injury.





 Warning
Indicates a potentially or very dangerous situation that, if not avoided, may cause serious personal injury or death.

 Warning
Indicates a potentially dangerous situation that may cause a certain degree of personal injury.

Attention
Indicates conditions that if not avoided, will cause damage to the instrument. This is information that needs special emphasis.

Warning Label

Please read all labels and marks attached to the instrument. Failure to follow the instructions on these safety labels may result in personal injury or damage to the instrument.

	If this symbol appears in the instrument, it means refer to the operation and/or safety information in the instruction manual.
	If there is this mark on the instrument housing or insulator, it means there is a risk of electric shock or death from electric shock.
	Static electricity can damage the delicate internal electronic components, resulting in reduced performance or eventual failure of the instrument.
	Electrical equipment marked with this symbol cannot be disposed of through the European public waste system after August 12, 2005. In order to comply with European regional and national regulations (EU Directive 2002 / 98 / EC), European electrical equipment users must now return abandoned or expired equipment to the manufacturer for disposal without any cost.

Catalog

1. Specifications.....	- 4 -
2. IK-765SS-O3 Panel Features	- 5 -
3. Dimension and Mounting	- 6 -
3.1. Dimension.....	- 6 -
3.2. Tube Connection.....	- 6 -
3.3. Terminal Wiring	- 7 -
4. Touch Screen Operation.....	- 8 -
4.1. Main Screen.....	- 8 -
4.2. User Login.....	- 8 -
4.3. Real-Time Monitoring.....	- 9 -
4.4. Explanation and use of the HOLD Feature.....	- 10 -
4.5. Menu Bar	- 11 -
4.6. Configurable Parameters	- 12 -
4.6.1. Alarm Parameters Setting.....	- 12 -
4.6.2. Sensor Parameters	- 13 -
4.6.3. Name Definition.....	- 13 -
4.6.4. Diagnostic Parameters.....	- 14 -
4.6.5. 4-20mA Output Parameters Setting.....	- 14 -
4.6.6. Communication Setting.....	- 15 -
4.7. Calibration	- 15 -
4.7.1. pH Calibration	- 16 -
4.7.2. O3 Calibration.....	- 17 -
4.8. Alarm View	- 18 -
4.9. Historical Data	- 19 -
4.10. Historical Data Curves.....	- 21 -
4.11. User Management.....	- 22 -
5. Maintenance	- 24 -
5.1. Correspondence Address	- 24 -
5.2. Operation and Maintenance	- 24 -
5.3. Instrument Alarms and Descriptions.....	- 25 -
6. Replacing pH and Oxidizer Electrode Head	- 26 -
7. Order Details	- 27 -

1. Specifications

Item	IK-765SS-O3
P/N	42091
Method	Bare Gold - Electrochemical Method
O3 Range	0.01 – 2.00 ppm as O3
Selectivity	Non-Selective / Cross Sensitive to other Oxidizing Species
pH Method	Electrochemical Method
pH Range	0.01 – 14.00 pH
Measurement Accuracy	±0.01 ppm or 1% Full Scale w/pH compensation to 9.0 ±0.01 pH
Minimum Resolution	0.01 ppm 0.01 pH
Response Time	T90 ≤ 180s – O3 T90 ≤ 90s – pH
Compliance	EPA-180.1/334.0
Measurement Interval	Continuous Measurement
Installation	ST-007 (316L) Flow Cell w/PRV-Rotameter-Hall Effect Flow Meter Included
ST-007 Minimum Flow Rate	200 mL/minute
ST-007 Maximum Flow Rate	400 mL/minute
ST-007 Sample Inlet	1/4 - inch OD
ST-007 Sample Outlet	1/4 - inch OD
Display	4.3-inch LCD Color Industrial Capacitive Touch Screen
Storage Capacity	Built-In 4GB of Ram for Storing up to 1-Million Data/Event Records
Power Requirement	96-260VAC / 50-60 Hz; 10A Fuse; 200 W
Output	2 x 4-20 mA / RS-485 Modbus - RTU / Modbus TCP
Input	RS-485 Modbus - RTU
USB	1 x USB host, for data downloading and screen upgrade
Internet	RJ-45 socket, Modbus-TCP
Panel Operational Temperature	40 – 113°F (4-45 °C)
Storage Temperature	Instrument: -4 – 131°F (-20 – 55°C) / Sensors 32 – 122°F (0 – 50°C)
Sample Water Temperature	40 – 104°F (4-40°C)
Sample Water Pressure	7.25 – 30 psi (0.05 – 0.2Mpa)
Rating	IP-65 Panel-Display / IP-67 Sensors
Regulation	CE / RoHS
Relative Humidity	20% - 90% (No Condensation)
Altitude	<6,561 feet (<2,000 Meter)
Approximate Product Weight	~ 15 kg

NOTE - Pyxis Lab is consistently updating technologies, as such, specifications may change without notice.
Contact info@pyxis-lab.com for details or www.pyxis-lab.com.

2. IK-765SS-O3 Panel Features

The IK-765SS-O3 is a dual-parameter inline water analyzer specifically designed as a 'Turn-Key' monitoring solution for clean water applications including bottled water production, drinking water networks, secondary water supply and alternative clean-water ozone treatment applications. The IK-765SS-O3 offers highly accurate, real-time measurement, display and data-logging of Ozone (O₃), pH and Temperature utilizing proprietary Pyxis Lab smart sensor technology, coupled with a Pyxis UC-80 touch screen display and data logging terminal. The IK-765 series is offered in a convenient and easy to integrate panel mounted format for rapid installation and simple maintenance.



Features

- Pyxis Lab's advanced research and development sensor technologies to achieve highly accurate and stable measurement of Ozone, pH, and Temperature.
- Pyxis ST-765SS-O3 is a three-parameter composite sensor used for the measurement residual ozone, pH, and temperature in compliance with USEPA 334.0 and ISO-7393 guidelines. The sensors advanced PCB offer built-in temperature and pH parameter compensation (up to pH 9.0+) algorithms eliminating the need for a supplemental pH sensor and controller. Unique Bare-Gold electrode technology for ozone measurement eliminates membranes and electrode solution replenishment commonly associated with conventional sensors. The ST-765SS Series has a uniquely designed flat bubble pH electrode design for reduced fouling potential. Reduce your maintenance and cost versus conventional electrochemical sensors by utilizing Pyxis replaceable Electrode Head (EH-765) for this sensor allowing for years of reliable service. The ST-765SS Series may be calibrated in-situ after cleaning via DPD or similar Ozone wet chemistry test measurement of active sample.
- Pyxis ST-007 Single-Sensor inline stainless steel flow cell provides an ozone demand-free environment for the safe installation and accurate operation of the ST-765SS-O3 sensor. The inlet and outlet to the ST-007 are 316L stainless steel with SwageLok fittings in ¼-inch OD. The IK-765SS-O3 panel is also equipped with inlet PRV, Rotameter and digital Hall Effect inlet flow meter for precise control and recording of the recommended flow range of 200-400 mL/minute. The outlet flow should be diverted to drain or the inlet of the pretreatment system for those desiring NSF compliance.
- Simple sensor removal and replacement. The ST-765SS Series sensors are connected to the display/data logger via RS-485 Modbus (RTU) allowing for integrated sensor calibration interface and diagnostics within the display screen.
- Convenient and simple to install Back-Panel (IK-765) for rapid and easy installation. Truly a plumb and power to go platform with intense factory setup, testing and sensor calibration prior to shipment.
- UC-80 touch screen color display/data logger prewired to the Pyxis sensor via RS-485 with calibration interface. Display/data logger offers 2x 4-20mA, RS-485 and TCP Modbus output with remote diagnosis and parameter adjustment. Pyxis PowerCloud™ 4G Gateway available as an optional accessory.

3. Dimension and Mounting

3.1. Dimension

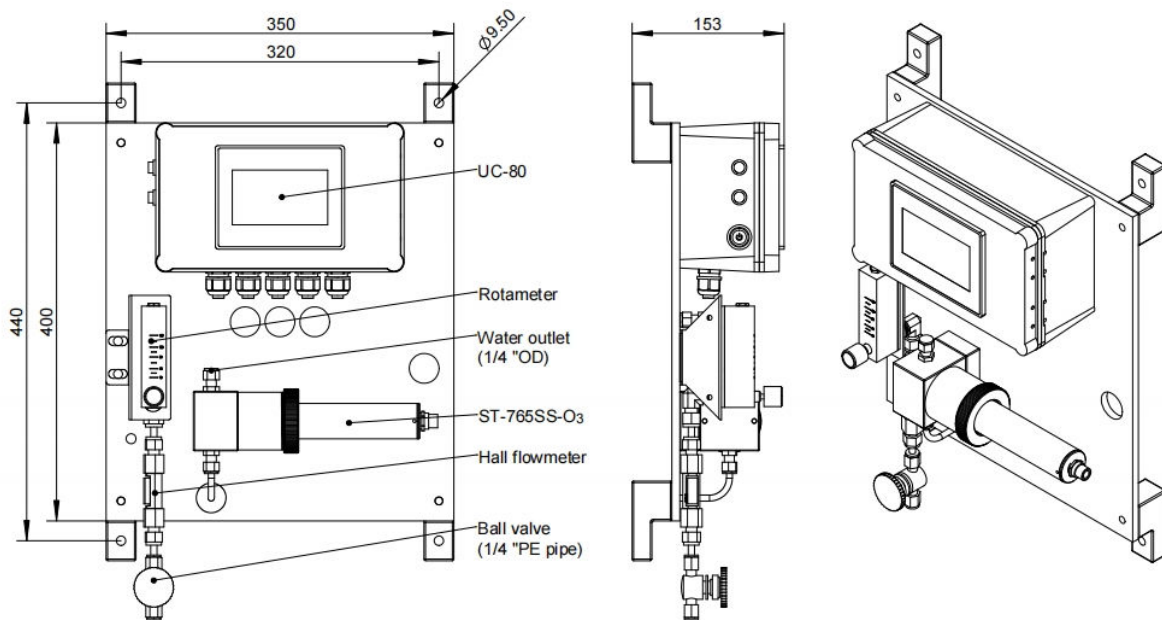

Figure. 1 - IK-765SS-O3 controller size and installation size

Power Supply: 100~240V AC 50/60Hz

Water Supply: Inlet water pressure should be from 7.25 – 30 psi (0.05-0.2MPa) with an inlet feedwater line diameter of ¼-inch PE pipe.

Drainage: Outlet pipe diameter is 1/4" OD, should both be connected to a discharge drain via gravity flow.

Wall Mount Space: The IK-765SS-DCL analyzer panel size is roughly 400H x 350W x153D (mm) in dimension. Please accommodate sufficient space for mounting.

Wall Mount Weight: Approximately 15kg. Please use appropriate mounting hardware.

3.2. Tube Connection

Inlet Water: Connect the ¼-inch inlet water tubing to the quick adapter provided.

Outlet Line: Connect ¼-inch stainless steel inlet tubing to stainless steel fittings.

3.3. Terminal Wiring

The IK-765SS-O3 analyzer has universal AC power supply equipment allowing users simply to plug the power supply into a 100~240V AC 50/60Hz power outlet for normal operation.

Warning

⚠ The process of electrical connection to contact the 220V single-phase power supply, should be operated by personnel with an electrician's license. Failure to operate according to the electrical code of practice may result in electric shock injury or even death.

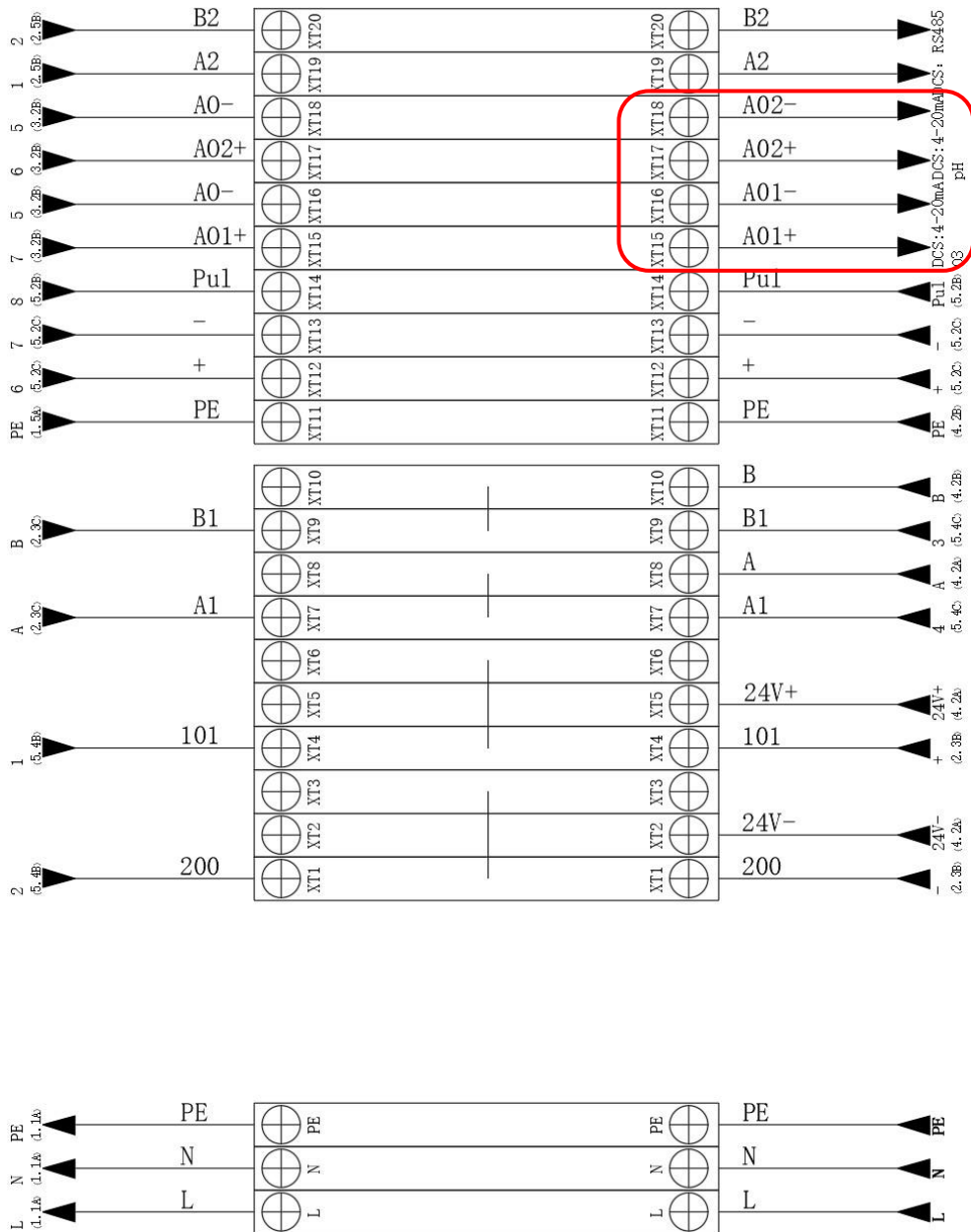

Figure. 2 - Terminal Wiring Diagram

4. Touch Screen Operation

4.1. Main Screen

After the system is powered on an initial screen allows the user to log into the system.



Figure. 3 - Main Screen

4.2. User Login

After powering on the system, log in with the username and password to be able to change system settings. Click the "User Login" button, select the user "pyxis-User", enter the password: "888888" in the user password field. A new user can be added via "User Management" in interface of the menu.

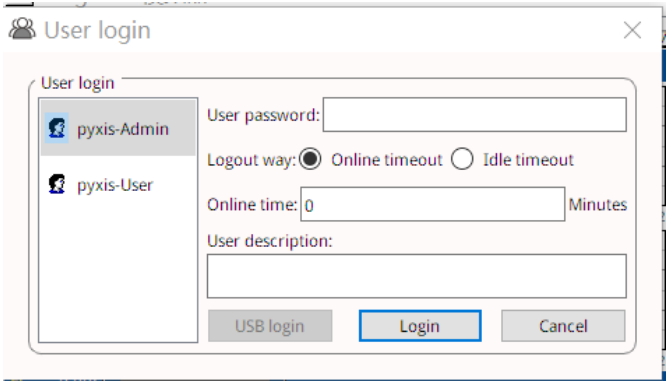

Figure. 4 - User Login Screen

If you do not need a password, or want to change the user, you can enter the system and manage in the "User Management" screen of the menu.

4.3. Real-Time Monitoring

Click the "Enter System" button on the main interface to enter the real-time monitoring screen of the system. The data detected by the Pyxis sensors will be displayed in real-time. See a functional overview of each section of this screen highlighted below. (numbers 1-4)

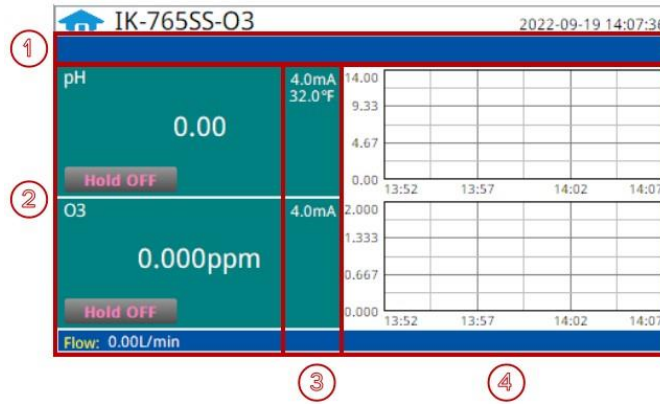

Figure. 5 - Real-time monitoring screen

Section Number	Functional Overview
1	The blue area will scroll any alarm information in real time until the alarm is cleared.
2	Real-time display of current sensor measurement value.
3	Real-time display of the current sensor's 4-20mA signal value.
4	Historical data is recorded as a live curve, with the horizontal coordinate being the time and the vertical coordinate being the measured value.

Table 1 - Main interface functional overview

Press and hold the curve area for 2 seconds and then let go, the Y-axis curve range setting dialog box will appear. Users may change the display value range of Y-axis for each measurement index curve. Click the outer area of the screen to save and exit the setting screen after modifications are made.

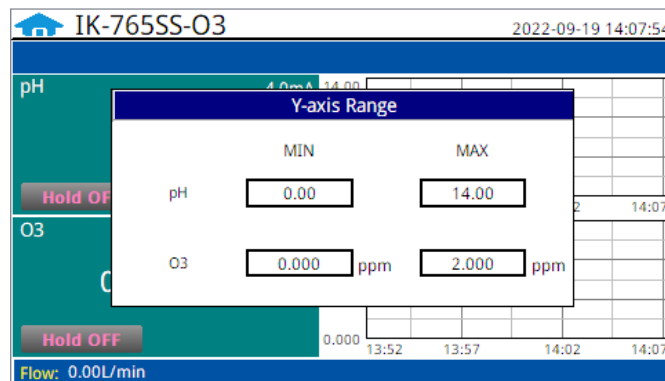

Figure. 6 - Curve Range Setting

4.4. Explanation and use of the HOLD Feature

Within the ADMIN USER ENTRY level, the IK-765SS-O3 has an integrated HOLD feature for all Modbus TCP output parameters from the sensor that would be connected to an onsite DCS network. The purpose for this feature is to allow the user to enter a signal value HOLD on the designated parameter during periods of sensor maintenance or removal. This feature prevents network system alarms from operational shutdown during sensor maintenance or replacement. Please refer to the Administration Instruction Guide for IK-765SS-O3 for login details to ADMIN level.

Click the "**Hold OFF**" button on the main interface to enter the HOLD setting interface.

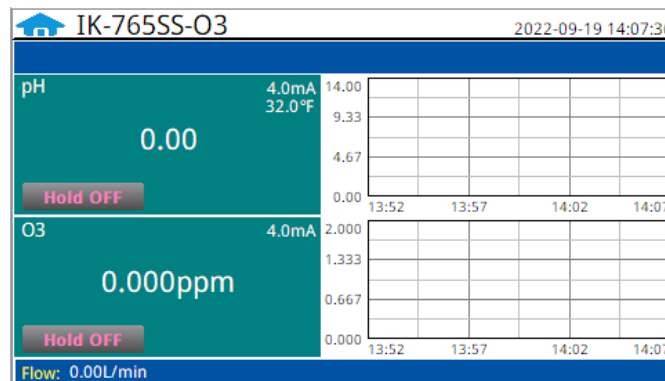

Figure. 7 - Main interface

In the pop-up box, enter the parameter value and click "**Confirm**" to open the "**Hold ON**" function. The main interface will display the entered value for 15 minutes, after which it will resume displaying the real-time value read by the sensor.

When the "Hold ON" function is activated by the user, the sensor may be maintained, calibrated, or removed and the Modbus TCP output will continue to retain the user entered value for a period of 15 minutes, ensuring network alarm and process will not be interrupted due to the sudden disappearance of the 'normal' value. The 'actual' live sensor reading along with the user entered hold value reading will both be displayed during this period.

Clicking "**Cancel**" will turn off this function, the main interface will immediately display the real-time value read by the sensor, and the main interface button will be displayed as "**Hold OFF**".

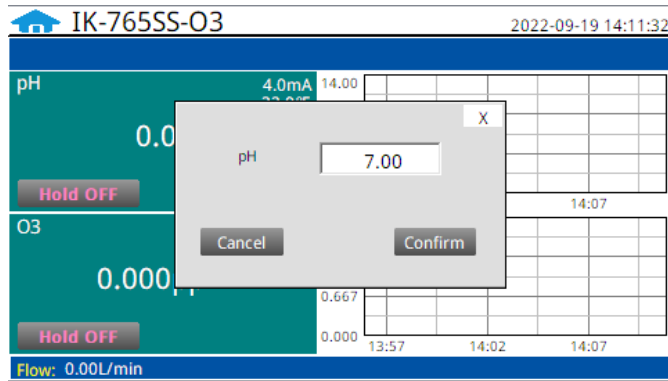

Figure. 8 - Hold Feature - pH Value Entry by User

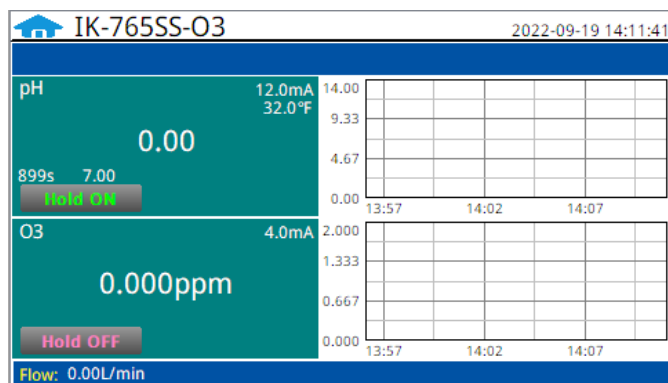

Figure. 9 - Hold ON interface

4.5. Menu Bar

Click the button in the upper left corner of the screen to enter the system's menu interface, where the user can select to enter the desired operation interface.

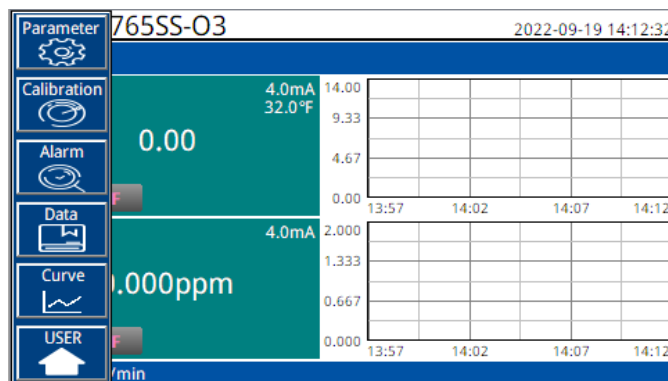

Figure. 10 - Menu Bar

4.6. Configurable Parameters

Click the "Parameter" button in the menu bar. Here you can select to enter "Alarm Parameters" and "4-20mA Output" setting interface etc.

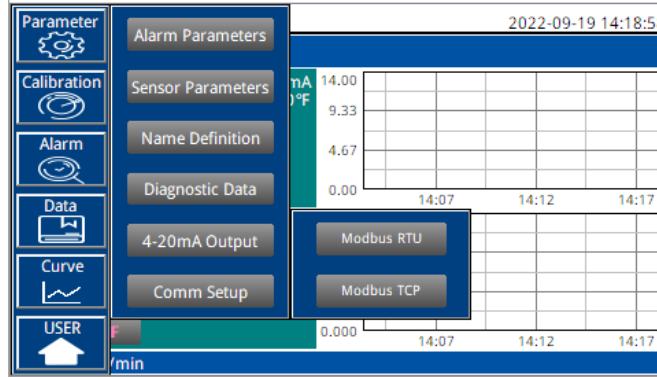

Figure. 11 - Parameter Settings

4.6.1. Alarm Parameters Setting

Users can set the upper and lower alarm limits. Click "Alarm Parameters" to enter the alarm parameter settings. When the measured sensor value is lower than the set lower limit (the XX lower limit alarm) or when the measured value is higher than the set upper limit (the XX upper limit alarm), the corresponding sensor alarm will be displayed on the real-time monitoring screen. The user can also choose to turn the alarm display on or off at the top left of the corresponding parameter list.

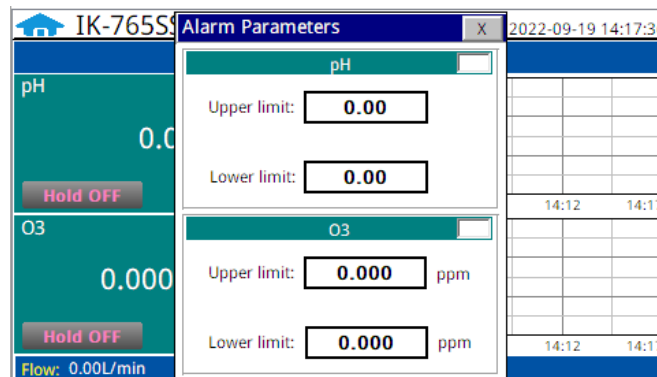

Figure. 12 - Alarm Parameter Setting

4.6.2. Sensor Parameters

Click ON in "Sensor Parameters" to activate the electrode properties. Activation ON will result in the electrode conducting internal cleaning voltammetry protocol for a duration of 12 seconds every 5 minutes of operation. During this time, sensor data will be suspended at previous reading value prior to activation then reinitiate after the 12 second cleaning is complete. To stop this feature, turn activation OFF.

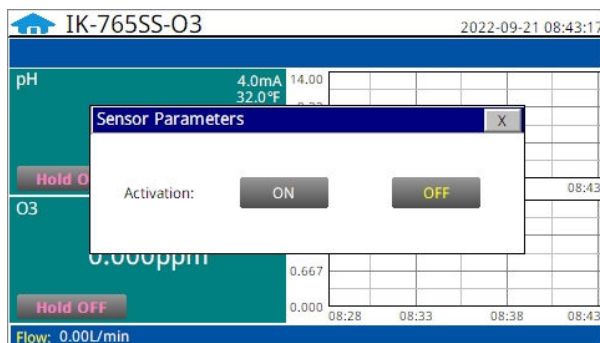

Figure. 13 Sensor Parameters

4.6.3. Name Definition

Click the orange dialog box to customize the sensor name.

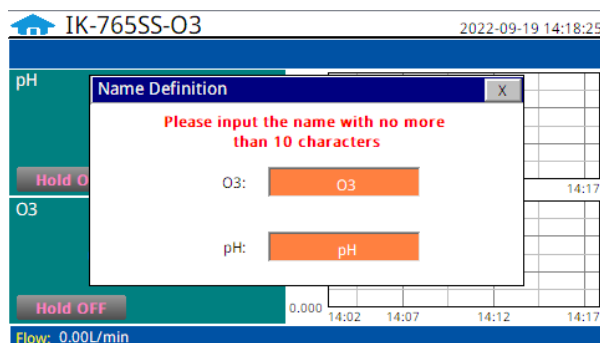

Figure. 14 - Name Definition

4.6.4. Diagnostic Parameters

Click "Diagnosis Parameters" on the diagnosis page. In the diagnosis page, the raw data measured by the probe is displayed. To help troubleshoot possible issues with the probe, please save an image of this data when the probe is placed in clean water (tap water or deionized water), in a standard, and in the sample that the probe is intended for.

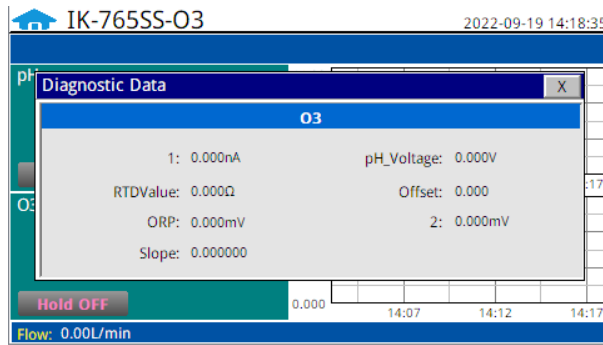

Figure. 15 - Diagnostic Parameters

4.6.5. 4-20mA Output Parameters Setting

Click "4-20mA Output " to enter the 4-20mA output parameter setting interface. The 4mA and 20mA output values should correspond to the lower and upper limits of the sensor range. ***NOTE*** The closer the value is set to the measurement value the more accurate the data. It is recommended to set according to the range of the sensor.

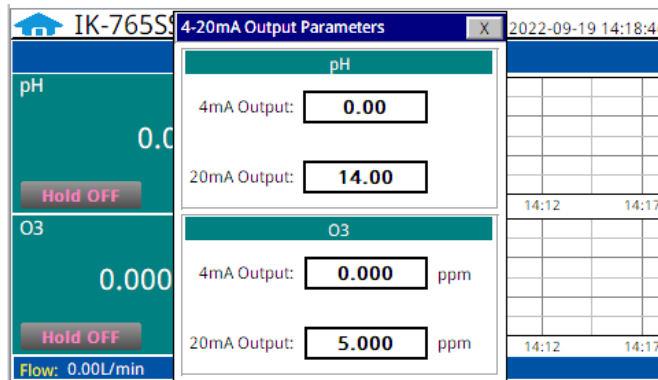

Figure. 16 - 4-20mA Output Setting

4.6.6. Communication Setting

Communication parameters generally do not need to be changed. If the communication station number and other parameters need to be changed on site, they can be changed on this interface.

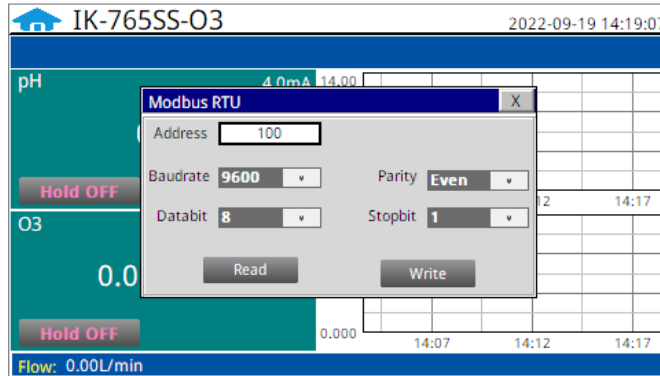

Figure. 17 - Modbus RTU

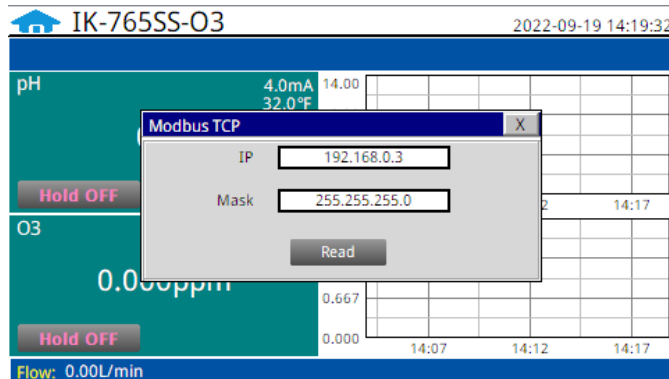

Figure. 18 - Modbus TCP

4.7. Calibration

Click on the "Calibration" button in the menu bar and select the sensor to be calibrated.

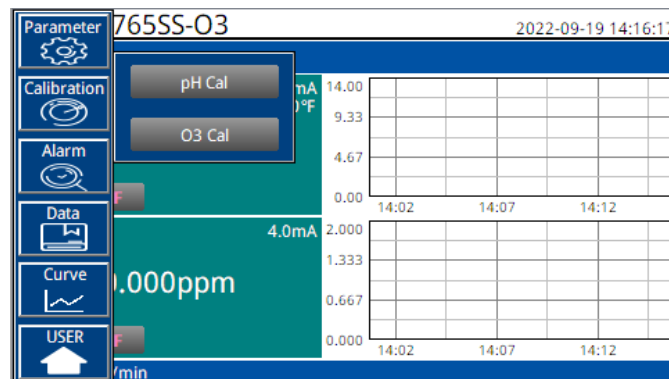

Figure. 19 - Sensor Calibration

4.7.1. pH Calibration

The pH function is thoroughly calibrated at the Pyxis Lab factory. After checking with a pH standard buffer solution, if the sensor value has shifted, then the user may choose from single-point, two-point or three-point calibration to re-calibrate the pH portion of the ST-765SS-O3 sensor as desired.

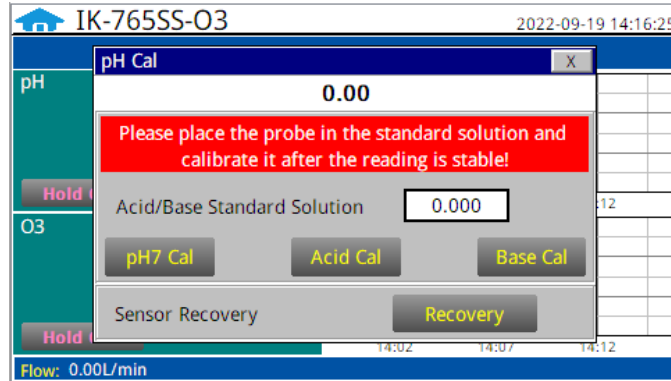

Figure. 20 - pH Calibration

Single Point pH Calibration

Remove the ST-765SS-O3 sensor and rinse 3x with DI water. Submerge the sensor into a beaker with pH=7 buffer solution. Click "pH7 calibration". A dialog box will pop up to confirm whether to perform this operation, click "OK" if the calibration operation is confirmed, if the calibration is successful the dialog box will show "calibration success".

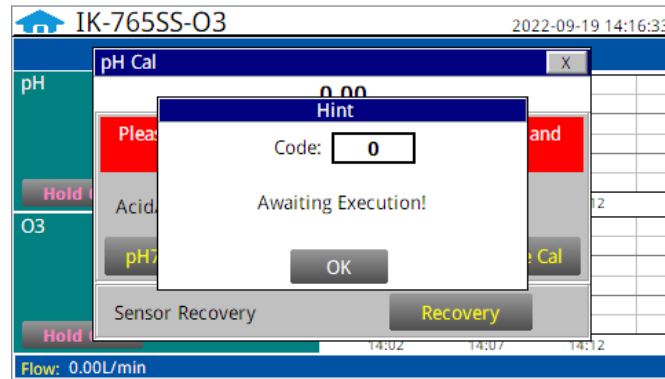

Figure. 21 - pH Calibration Success Prompt

Two Point pH Calibration

Remove the ST-765SS-O3 sensor and rinse 3x with DI water. Submerge the sensor into a beaker with pH=7 buffer solution. Click "pH7 calibration". A dialog box will pop up to confirm whether to perform this operation, click "OK" if the calibration operation is confirmed, if the calibration is successful the dialog box will show "calibration success".

After pH7 is successfully calibrated, you can choose acid calibration or alkali calibration for the second calibration point. If you choose acid calibration, clean beaker 3x with deionized water. Fill the beaker with pH=4 buffer solution. Enter the value 4 in the calibration value dialog box, and click "Acid Calibration", then a dialog box will pop up to confirm whether to perform this operation. Click "OK" if the calibration operation is confirmed and the dialog box will show "Calibration Successful" if the calibration is successful. Similarly, a pH=10 buffer solution can be selected for the second point calibration if desired.

Three Point pH Calibration

Remove the ST-765SS-O3 sensor and rinse 3x with DI water. Submerge the sensor into a beaker with pH=7 buffer solution. Click "pH7 calibration". A dialog box will pop up to confirm whether to perform this operation, click "OK" if the calibration operation is confirmed, if the calibration is successful the dialog box will show "calibration success".

After pH7 is successfully calibrated, you can choose acid calibration or alkali calibration for the second calibration point. If you choose acid calibration, clean the beaker 3x with deionized water. Fill the beaker with pH=4 buffer solution. Enter the value 4 in the calibration value dialog box, and click "Acid Calibration", then a dialog box will pop up to confirm whether to perform this operation. Click "OK" if the calibration operation is confirmed and the dialog box will show "Calibration Successful" if the calibration is successful.

After successful acid calibration, select pH=10 for alkali calibration. Clean the beaker 3x with deionized water. Fill the beaker with pH=10 buffer solution. Enter the value 10 in the calibration value dialog box, and click "Alkali Calibration", then a dialog box will pop up to confirm whether to perform this operation. Click "OK" if the calibration operation is confirmed and the dialog box will show "Calibration Successful" if the calibration is successful. The three-point calibration is completed.

4.7.2. O3 Calibration

The measurement module of the ST-765SS-O3 sensor is thoroughly calibrated at the Pyxis Lab factory. To calibrate, the user can perform a single point according to the requirements of the application. (USEPA-334.0 / ISO-7393 compliant methodology)

Calibration of the ST-765SS-O3 sensor for ozone should be done with the sensor inline exposed to active flowing sample water. Use a portable or laboratory colorimeter (i.e. Pyxis SP-200 / SP-800 / SP-910 or similar) to test the active (flowing) water sample in the flow tee assembly of the IK-765SS-O3 panel. Once you have tested and confirmed the concentration value in the active (flowing) flow tee assembly, enter the test result value of the portable or laboratory colorimeter in Calibration Screen and click "High Cal". A dialog box will pop up to confirm whether to perform this operation. If the calibration operation is confirmed, click "OK", and if the calibration is successful, the dialog box will show "Calibration Success".

NOTE Click the restore button in the calibration interface of each sensor to restore the data of pH/residual O3 sensor. If a user error is made during calibration and other operations, you may restore the factory settings of the sensor through the restore function.

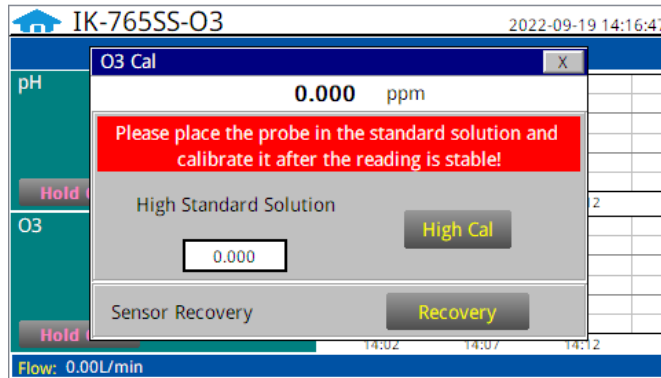

Figure. 22 - O3 Calibration

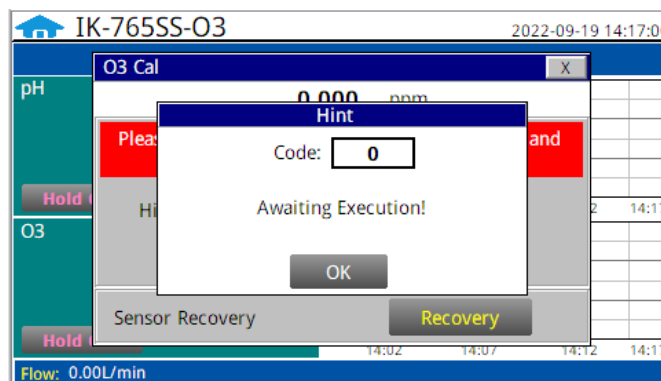

Figure. 23 - Awaiting execution Screen of O3 Calibration

4.8. Alarm View

Click the "Alarm View" button on the main screen to enter the alarm view screen.

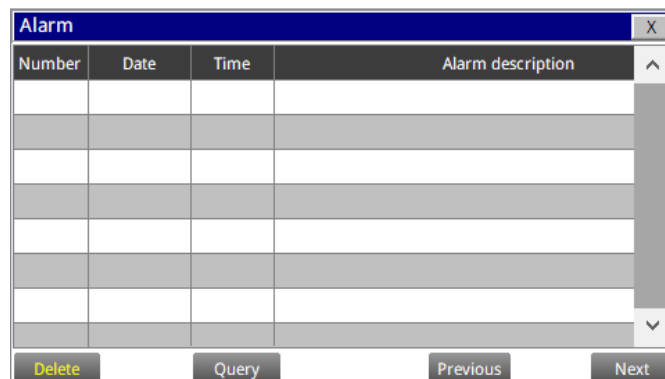

Figure. 24 - Alarm View

In this screen users can browse all logged alarms. Drag the right scroll bar up and down to view the history of alarms. Click "Previous" and "Next" to advance to the next page. Click "Query" then enter the alarm number in the pop-up box to query that alarm.

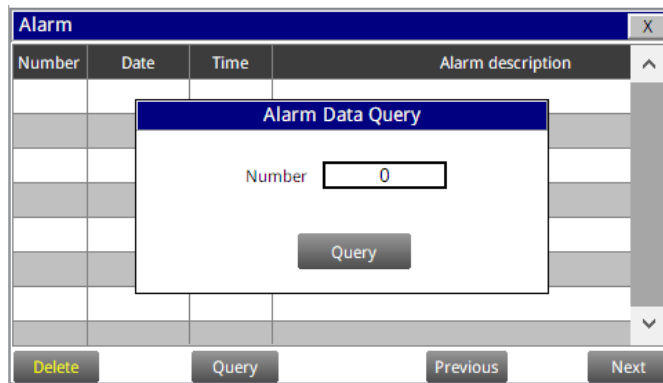

Figure. 25 - Alarm Data Query Screen

The Delete button in the lower left corner will delete all alarm records. After clicking delete, you must exit the screen and reenter before the historical data within the data report is cleared.

4.9. Historical Data

Click the "Historical Data" button in the menu bar to enter the data report interface.

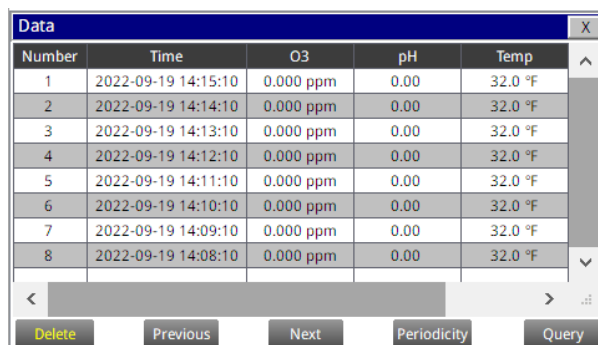

Figure. 26 Historical Data Screen

In the data report, the user can view the stored data of all parameters. The system records sensor readings every 4 seconds by default but this can be edited by the user if desired. Drag the scroll bar on the right to slide up or down or click "Previous" and "Next" to view historical data records. The data record can save up to 100,000 data entries. New data will overwrite the previously saved data after recording 100,000 data entries. The user can click the "Periodicity" button to change the data recording time interval.

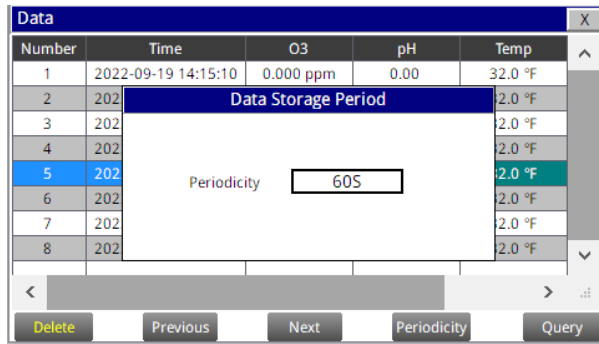

Figure. 27 Data Storage Cycle Time Setting

Click “Delete” in the lower left corner. After entering the retention time, click the “Delete” button to clear all historical data within the retention time range.

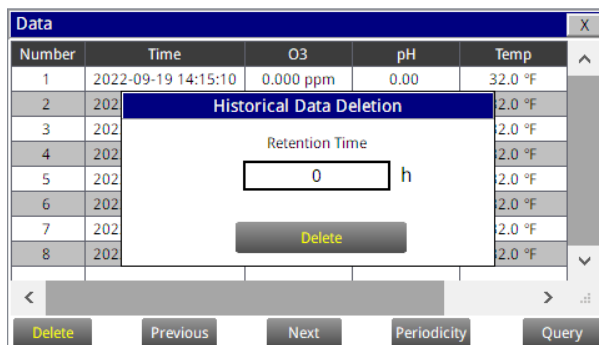

Figure. 28 - Historical Data Deletion Screen

Click the “Query” button in the lower right corner, enter the start time and end time and then click the “Query” button. Note that the start time and end time must be filled in exactly and completely according to the system time format.

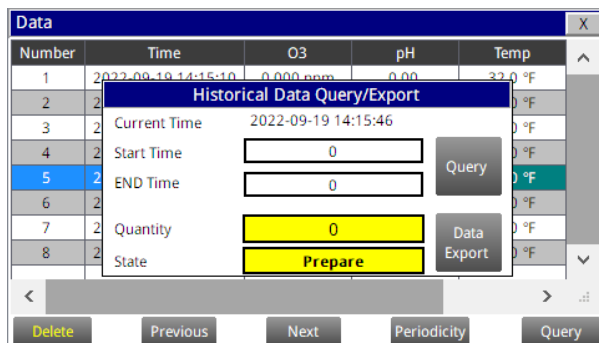

Figure. 29 - Historical Data Query and Export Screen

Insert a USB disk behind the display screen and enter the time range of the data to be exported in the query area. Click on the “Data Export” to download the data to the USB disk. The data quantity will be shown as a positive number if data export is successful. If the data export was not successful, please check whether the time format is correct.

4.10. Historical Data Curves

Click the "Historical Curve" button in the menu bar to enter the trend curve interface. You can click the buttons below the X-axis to browse and view the values in a different time range. Click on Y-axis Range to change the minimum and maximum Y-axis values for a proper range.

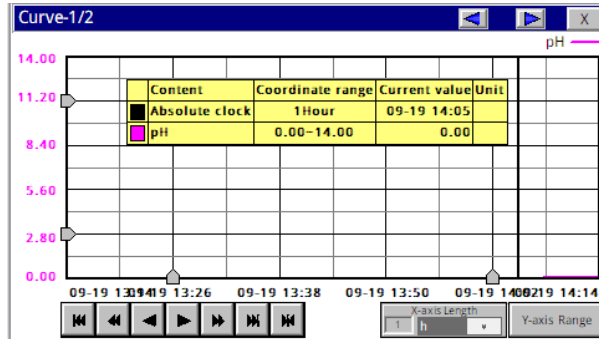

Figure. 30 - History Curve Screen

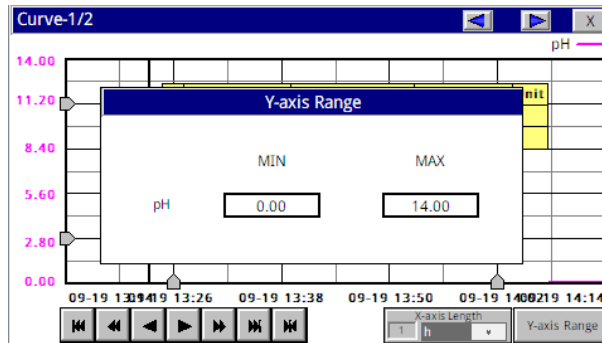

Figure. 31 - Y-axis Range Setting

- ⏪ The curve will scroll back (to the left of the X-axis) one page
- ⏩ The curve will scroll back (to the left of the X-axis) half the page of the curve
- ⏴ The curve will scroll backward (to the left of the X-axis) to a position where the main line is drawn
- ⏵ The curve will scroll forward (to the right of the X-axis) to a position where the main line is drawn
- ⏴⏵ The curve will scroll forward (to the right of the X-axis) half the page of the curve
- ⏵⏴ The curve will scroll forward (to the right of the X-axis) one page
- ⏴⏴ The curve will scroll forward (to the right of the X-axis) one page
- ⏴⏴ A dialog box will pop up to reset the starting time of the curve

Figure. 32 - Button Function Review

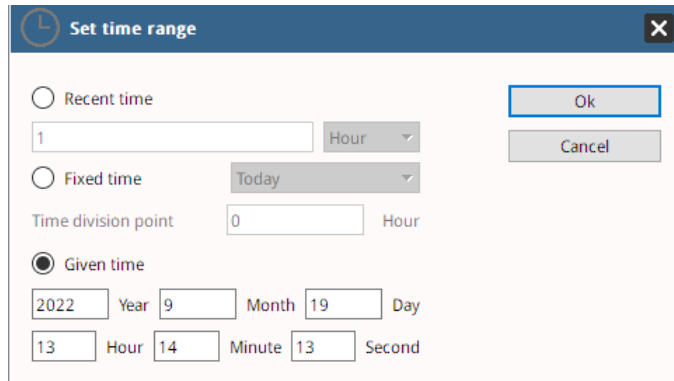

Figure. 33 - Time Setting Screen

4.11. User Management

Click the "User" button on the menu bar and then you can select "Login", "Logout" and "Manage" operations.



Figure 40. – User Management

Logout enables the user to log out of the logged-in state and only view the real-time readings but cannot perform operations such as parameter settings. Click "Manage" to enter the user management interface, where you can add users, change passwords and other operations. Users can set their own username and password and select the user group they belong to. Only users in the administrator group can set parameters such as calibration.

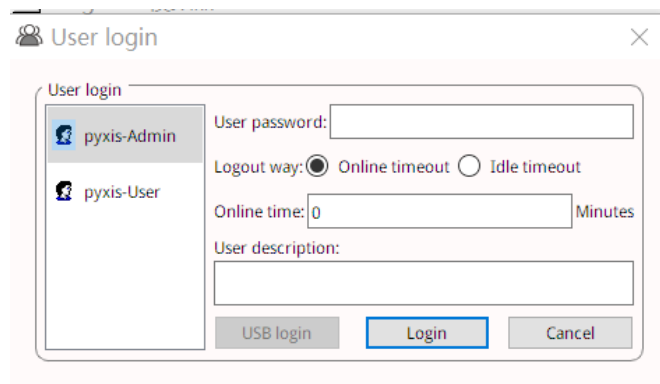

Figure. 34 - User Management Screen

Modify Password: Select the user you want to change, then click Modify User button, enter the user's own password in the User Password column and Confirm Password column, and click Confirm to modify successfully. ***NOTE*** *If you do not want to set the password, you can delete the password and save it.*

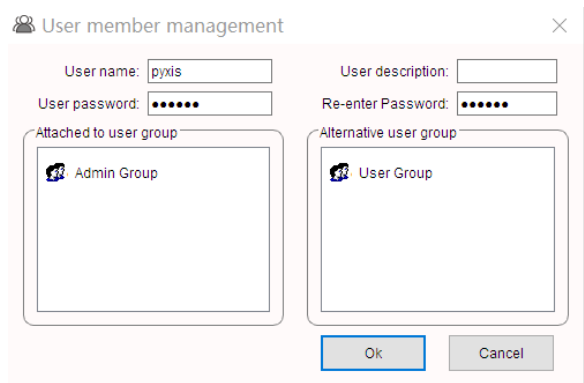

Figure. 35 Modifying the User Screen

5. Maintenance

5.1. Correspondence Address

Table. 1 Correspondence Address

Number	Definition	Address	Format	Mode	Unit	Note
1	O3	1	float	read only	ppm	Data format ABCD
2	pH	3	float	read only		Data format ABCD
3	Temp	5	float	read only	°F	Data format ABCD
4	Flow	7	float	read only	L/min	Data format ABCD
5	O3 lower limit alarm	9	uint	read only		0: normal 1: Alarm
6	O3 upper limit alarm	10	uint	read only		0: normal 1: Alarm
7	pH lower limit alarm	11	uint	read only		0: normal 1: Alarm
8	pH upper limit alarm	12	uint	read only		0: normal 1: Alarm
9	O3 sensor communication is abnormal	13	uint	read only		0: normal 1: Alarm
10	The communication of the analog module is abnormal	14	uint	read only		0: normal 1: Alarm
11	The communication of the traffic collection module is abnormal.	15	uint	read only		0: normal 1: Alarm
Communication Protocol: Standard Modbus-RTU						
Communication Parameters: Baud Rate - 9600, Data Bit - 8, Stop Bit - 1, Parity Bit - Even						
Station Number: 100						
Communication protocol: standard Modbus-TCP						
Communication parameters: IP: 192.168.0.3 (can be set); port: 502						
Station number: 1						

5.2. Operation and Maintenance

After the analyzer is installed by a qualified technician, it can begin to monitor water quality. The IK-765SS-O3 is designed to be simple to operate, but still requires some regular maintenance. Actual system maintenance may vary depending on the installation conditions and usage. Please refer to the table below as a general recommended maintenance schedule guideline. Little operator intervention is required during normal operation.

Table. 2 Maintenance Intervals

Required Services	Recommended Frequency
pH Calibration	Every 6 Months
O3 Calibration	Every 6 Months

5.3. Instrument Alarms and Descriptions

Please refer to the instrument alarms and descriptions table when troubleshooting the IK-765SS-O3 issues an alarm or indicates abnormal measurement data.

Table. 3 Common Alarms

Alarms	Description	Symptoms	Solutions/Recommendations
PLC Communication Abnormalities	PLC without Communication		Check if the wiring inside the PLC and control box is loose
pH / O3 Sensor Communication Abnormalities	pH / O3 Sensor without Communication	No pH and O3 Measurements	Check the connection between the sensor and the circuit board. If the problem persists, contact Pyxis.
pH Upper Limit Alarm	pH above the Alarm Setting	Information Only	Compare with manual measurement readings. Check and clean line valves. Check that water flow is normal. Check that the sensor is clean.
pH Lower Limit Alarm	pH below the Alarm Setting	Information Only	
O3 Upper Limit Alarm	O3 above the Alarm Setting	Information Only	
O3 Lower Limit Alarm	O3 below the Alarm Setting	Information Only	
pH/O3 Calibration Failure Code 2		Calibration Failure	Check whether the water flow is normal, whether the sensor is clean, whether the standard liquid is contaminated
pH/O3 Calibration Failure Code 3	Standard Solution Value out of Range	Calibration Failure	
pH/O3 Calibration Failure Code 5	Wrong Data Type for the Liquid Value	Calibration Failure	

6. Replacing pH and Oxidizer Electrode Head

The pH/oxidizer electrode head of ST-765SS-O3 sensor can be replaced when the original electrode head reaches its working life. Order a replacement electrode head EH-765-O3 (P/N 22603) from Pyxis and follow instructions below.

1. Turn off the sensor if it is powered on.
2. Make sure there is no water on the sensor.
3. Hold the ST-765SS-O3 main body with one hand and use the other hand to twist the stainless-steel locking ring counter-clockwise until the front end of the black electrode is completely unscrewed, as shown in *Figure 36-2*.
4. Pull out the electrode head as shown in *Figure 36-3*.
5. Loosen the electrode plug connector, and remove the electrode head, as shown in *Figure 36-4*.
6. To assemble the new electrode head, connect the plug, then insert the new electrode head into the main sensor housing and ensure that the two protrusions on the electrode head are aligned with the notches in the sensor main housing.
7. Then twist the stainless-steel lock ring of ST-765SS-O3 in a clockwise direction until the threads of the electrode head completely enter the ST-765SS-O3 housing as shown in *Figure 36-1*.

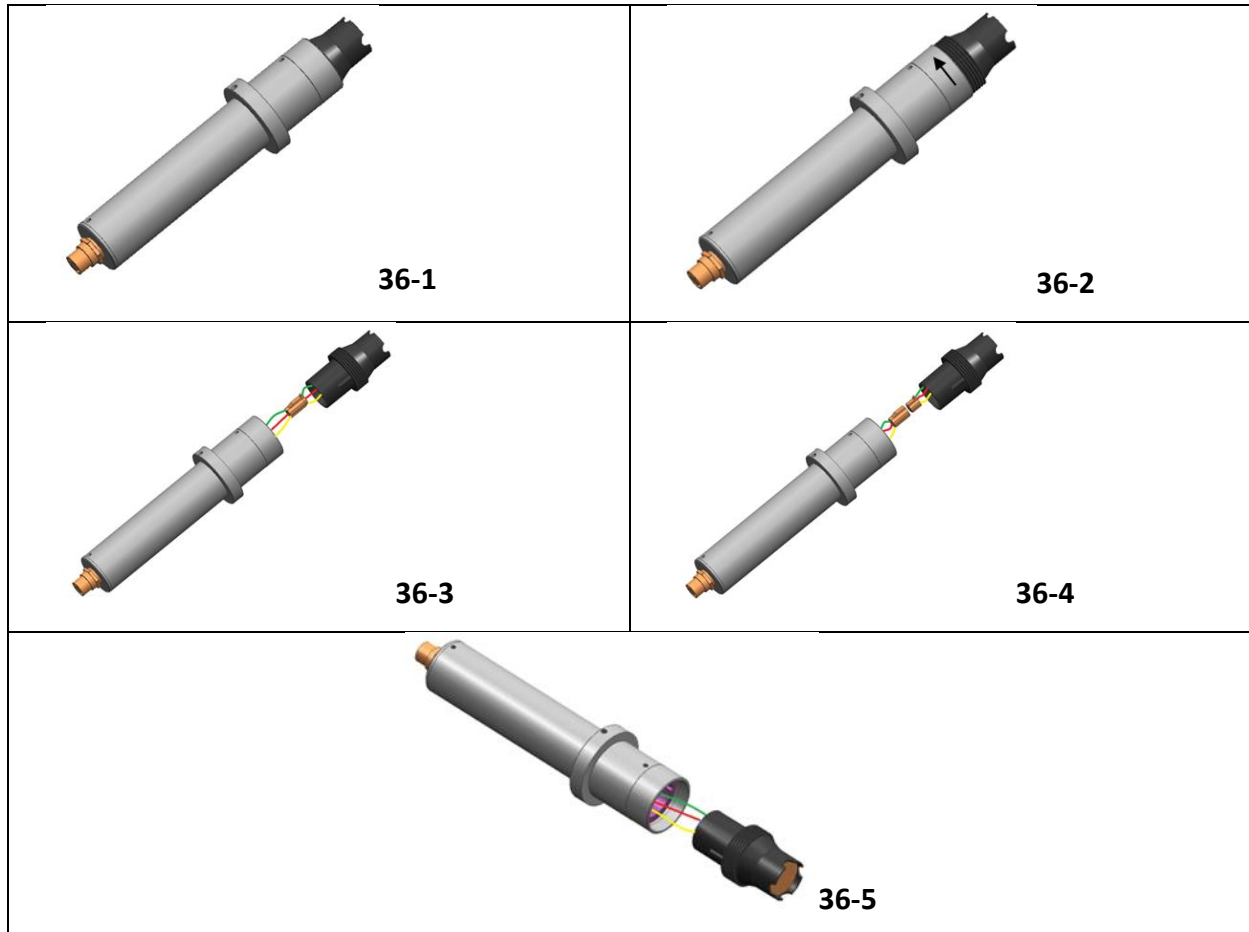

Figure 36 - Replacing EH-765-O3 pH and Oxidizer Electrode Head

7. Order Details

Order Information

IK-765SS-O3 (*Ozone + pH + Temperature Analyzer*)

P/N

42091

Optional / Replacement Accessories Information

ST-765SS-O3 (*Ozone + pH + Temperature Sensor w/Internal Compensation*)

P/N

53614

EH-765-O3 (*Replacement Electrode Head for ST-765SS-O3*)

22603

ST-007 (*Replacement ST-007 Stainless Steel Flow Cell*)

50700-A51

Rotameter Assembly Kit (*Replacement 0- 1.8LPM*)

22876

Stainless Steel Hall Effect Digital Flow Meter (*1/4-inch OD*)

22501

UC-80 Display + Data Logging Terminal (*Replacement*)

14003

Pyxis pH Combo Calibration Pack (*pH 4-7-10 Calibration Solution 3-Pack - 500mL ea.*)

57007

SP-200 OxiPocket™ (*Pocket All-Oxidizing Disinfectants Colorimeter & Fluorometer*)

50802

Contact Pyxis Lab

info@pyxis-lab.com for general inquiries

service@pyxis-lab.com for technical service and support

order@pyxis-lab.com for order and pricing inquiries

1-866-203-8397 Phone USA for all needs

Office Hours 7AM – 5PM Central Time USA